 A BRIARWOOD COMPANY



Fibre Cement Design Guide

The UK's only British Farmer Owned
Fibre Cement roofing manufacturer



Search for **Briarwood**

Contents

Properties and performance

- 7. What is fibre cement?
- 8. Condensation control
 - Sound insulation
 - Durability
 - Impact resistance
 - Thermal conductivity
 - Reinforcement strips
 - Maintenance
 - Fire reaction
 - Water resistant
- 9. Guarantees and warranties
 - Quality and certifications
- 10. EUROSIX
 - Technical data
- 12. Health & Safety Data

Designing your roof

- 14. Ventilation systems
- 15. Open protected ridge systems
 - Open un-protected ridge systems
- 16. Raised curved ridges
 - The stack effect
- 17. Ventilated ridges
- 18. Spaced roofs
 - Breathing roofs
- 19. Wind loadings
 - Exposure zones
- 20. Lap treatments
- 21. Setting out the roof
- 22. Mitring
- 23. Fixing
- 24. Vertical cladding
- 25. Colour range
- 26. Typical GRP rooflight configurations

Accessories

- 28. Bargeboards
- 29. Close fitting one piece ridges
- 30. Adjustable two piece ridges
- 31. Finials
- 32. Movement joints
- 33. Apron flashings
- 34. Eaves detail
 - Foam eave fillers
 - Plastic eave fillers
- 35. Solar panels guidance

Handling and storage

- 38. General storage advice
- 39. Handling advice





BUILDING AGRICULTURE SINCE 1978

Future-proof and invest into your farm by protecting your livestock, crop and machinery starting with Briarwood

ABOUT OUR DESIGN GUIDE

Our 'Fibre Cement Design Guide' has been created exclusively with designers and our customers put at the forefront; allowing readers to understand the key points, details and specification of all of our Briarwood fibre cement products.

Whilst this has been written to be simple and easy to read, more information can be found directly on our website, alternatively the reader can contact our technical department.

Farming family owned business based in the heart of Somerset, UK

We are the UK's leading supplier and manufacturer of Fibre Cement, holding the largest stock of sheets in Europe. The Briarwood production facility and distribution centre provides a seamless supply chain of the finest roofing systems and building products for the agricultural, industrial and domestic sectors – direct to clients from the factory floor.

As a British Farming Family, supporting the British Agricultural market has always been our goal. We have been helping to develop farms since 1978 by supplying the highest quality products specifically designed for the UK to help increase production and efficiency.



MANUFACTURER
GUARANTEE



UNBEATABLE
DELIVERY



LARGEST UK
STOCKPILE



24 HOUR
QUOTING



All of your roofing needs...

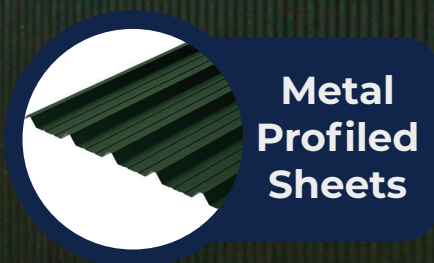

OVER 20 SPECIALIST VEHICLES

Our specialist vehicles and exceptionally trained delivery team enables Briarwood to deliver to challenging of sites and locations nationwide.

Many of our deliveries are made using articulated vehicles with truck mounted forklifts for efficient offloading.

Our transport fleet is owned by Briarwood and all of our drivers are trained in farm deliveries and restricted access situations.

Manufactured roofing products delivered direct to site.

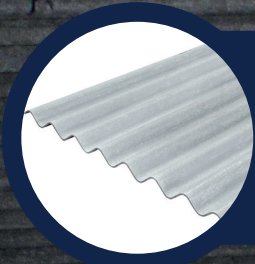

**Fibre
cement
roofing
sheets**

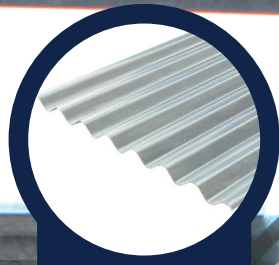

**GRP
Roof
Lights**

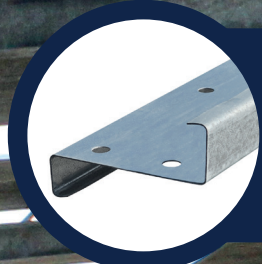

Purlins



Timber

...all under one roof...





Properties and performance

- What is fibre cement?
- Condensation control
- Sound insulation
- Durability
- Impact resistance
- Quality
- Guarantees
- Technical data
- Health and safety

What is fibre cement?

BRIARWOOD FIBRE CEMENT PRODUCTS

For generations, Briarwood have been supplying fibre cement products to agricultural, industrial and domestic projects over the UK to help build long-lasting structures. Our Fibre Cement Sheets are made using a compound mixture of cement, air, water, cellulose and reinforcement fibres.

WHAT ARE THE ADVANTAGES OF USING FIBRE CEMENT?

- Vapour permeability significantly reduces condensation
- High resistance to corrosion which increases the life expectancy of the product
- Low thermal conductivity reduces heat build-up in the Summer and heat loss in the Winter
- Excellent acoustic insulation.
- Class 1 fire rated
- Wide range of accessories and colours available.
- Maintenance free product.
- Normal life expectancy of 50 years.
- Manufactured to a quality system registered under BS EN ISO 9001.
- Complies with BS EN 494 requirements for Class 1X sheeting.
- EUROSIX should be classified as fragile after laid on the structure and meets the latest requirements for roof safety as laid down by the Health and Safety Executive.
- Guaranteed 30 year life expectancy covered under our Manufacturer Guarantee

ADVANTAGE	FIBRE CEMENT	METAL PROFILES
Combustability	Class 1 fire rated	Class 2 fire rated
Water resistant	✓	✓
Resistant to rotting and warping	✓	✗
Easy to install	✓	✓
Lifespan	Up to 50 years	Up to 20 years
Moisture absorbency	Up to 25% of its weight	✗
Insulation	✓	✗
Minimises condensation	✓	✗
Acoustic insulation	✓	✗



Advantages

CONDENSATION CONTROL

Not only is our EUROSIX fibre cement sheets water resistant, but with efficient ventilation they also have the ability to absorb up to 25% of its own dry weight in moisture to then evaporate it in different conditions. With this advantage, this is one of many key features in reducing and controlling condensation.

SOUND INSULATION

Unlike metal profile sheets, our fibre cement sheets has been tested to have an average sound reduction value of 28 decibels. This is especially useful within the equestrian sector and livestock buildings because normally horses can scare quite easily so our fibre cement sheets act as a good sound reduction layer.

DURABILITY

EUROSIX fibre cement sheets have a normal life expectancy of at least 50 years, however we would always advise to look into the durability of the fixings applied onto the product. We will personally guarantee the EUROSIX fibre cement sheeting for 30 years as standard as part of our 30-year manufacturer guarantee.

IMPACT RESISTANCE

The test for fragility of roofing assemblies ACR (M) 001:2005 consists of a 45kg bag being dropped from a height of 1200 mm onto a sample of roofing. The purpose is to provide information to prove that the sample roof can withstand instantaneous imposed weights which are designed to impersonate a person falling or dropping onto it. If the sample load does not break through the sample roofing structure, the roof is then classified as a Class C non-fragile roof.

Our EUROSIX fibre cement sheets meets the Class C non-fragile roof classification with the help of our reinforcement strips manufactured into the product.

THERMAL CONDUCTIVITY

Due to the low thermal conductivity of the fibre cement sheets, it helps reduce heat build-up in the Summer whilst in the Winter, it helps prevent heat loss. The thermal conductivity value is 0.34 W/mK.

REINFORCEMENT STRIPS

Manufactured into our EUROSIX fibre cement sheets are polypropylene reinforcement strips inserted at precise locations which run along the entire length of the sheet; providing maximum impact strength without affecting the durability and style of the product. The reinforcement strips manufactured into our fibre cement sheeting are wider, stronger and strategically placed inside of the product making them the highest spec used in any fibre cement sheeting.

MAINTENANCE

Our natural grey and Meadowscape fibre cement sheets require zero maintenance in order to achieve the products expected lifespan, however for sheets in our standard/extended colour range, they should be 'treated' every 10-20 years.

PRODUCT WEIGHT

All of our fibre cement roof sheet weights will vary depending on the chosen length required for structures design. The average installed dry weight when laid is 18.0kg/m².

FIRE REACTION

Our fibre cement sheets are Class 1 fire rated and has been tested to the standard BS 476/7 of 1997.

WATER RESISTANT

Briarwood's EUROSIX fibre cement roof sheets are classified as water resistant meaning that water exposure (both light impact and heavy) will not ever negatively impact the face of the sheets. Our fibre cement sheeting is water resistant and follows inline with the BS EN 494 standard.





Guarantees and warranties

We guarantee...

When you purchase one of our products, we want to give you the peace-of-mind knowing that you have the right guarantees and warranties.

Our guarantees are so strong, we are willing to put our reputation on the line and stamp our name on it.

- ...**30 year manufacturer guarantee** on EUROSIX sheets!
- ...**an unbeatable delivery service** with offload!
- ...**that we have stock readily available!**
- ...**we can provide you with a quote within 24 hours!**



**MANUFACTURER
GUARANTEE**



**UNBEATABLE
DELIVERY**



**LARGEST UK
STOCKPILE**



**24 HOUR
QUOTING**

Quality and certifications

Briarwoods EUROSIX fibre cement roofing sheets are manufactured in accordance with a quality assurance system to BS EN ISO 9001: 2008, ISO 14001:2004 and to the requirements of BS EN 494: 2004 Class C1X.

Briarwood has also been awarded the BBA Certificate Number 03/4059 for fibre cement sheets and matching accessories (including ridges, bargeboards and others).



EUROSIX

EUROSIX Fibre Cement Profiled sheets provide the optimal roofing or cladding solution for any agricultural, industrial, commercial or domestic building. The fibre cement sheet allows natural ventilation to a building, absorbing condensation and promoting the flow of fresh air.

EUROSIX comes with a range of accessories designed to offer ventilation options to suit every building type. It also provides natural thermal properties and acoustic insulation offering protection against harsher weather conditions.



MANUFACTURER
GUARANTEE



UNBEATABLE
DELIVERY



LARGEST UK
STOCKPILE



24 HOUR
QUOTING



CATTLE BUILDINGS



PIG UNITS



LIVESTOCK BUILDINGS



GRAIN STORES



FOOD STORAGE



INDOOR RIDING ARENAS



HORSE STABLES

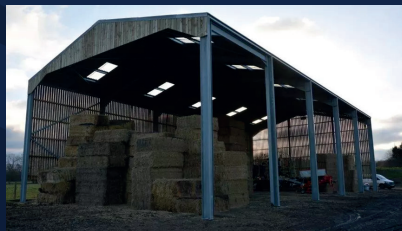

STRAW/HAYLAGE STORE



FARM BUILDINGS



MULTIPURPOSE BUILDINGS



MACHINERY HOUSING



WORKSHOPS



EUROSIX

Technical specifications



EUROSIX is a strong fibre cement sheet reinforced with polypropylene strips that have been inserted in specific locations which run across the entire length of the sheet; thus providing maximum impact strength without negatively affecting the look, durability and practicality of the product.

WHY INVEST IN EUROSIX?

- Highest quality fibre cement roofing in Britain
- Perfect for cattle and dairy farming, equestrian centres and agricultural sheds
- Minimises condensation
- High resistance to corrosion
- Excellent acoustic insulation
- Low thermal conductivity reduces heat build-up in the summer and prevents heat loss in the winter
- Class 1 fire rated
- 30 year manufacturers guarantee
- UKCA mark approved
- Manufactured to BS EN ISO 9001 standards
- Complies with BS EN 494 requirements for Class 1X sheeting
- Wide range of accessories

Huge range of fibre cement accessories which compliment our EUROSIX range

Not only do Briarwood manufacture and supply the UK's favourite fibre cement sheeting; EUROSIX, but we also supply a full comprehensive range of high quality fibre cement fittings and accessories to compliment our EUROSIX sheet.

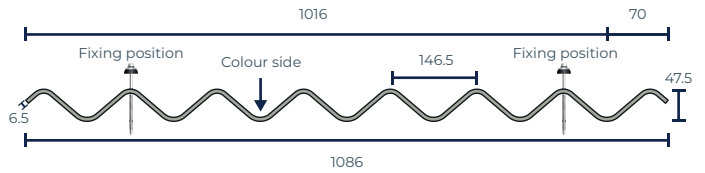

TECHNICAL DATA

Overall width	1086 mm
Cover width	1016 mm
Thickness	6.5 mm
Corrugation pitch	146.5 mm
Depth of profile	47.6 mm
Side lap	70 mm
Minimum end lap	150 mm
Minimum roof pitch	5°
Maximum unsupported overhang	350 mm
Standard colour	Natural grey
Class	C1X
Maximum purlin centres	1375 mm
Maximum rail centres	1825 mm
Approx.weight when installed	17kg/m2

LENGTHS AND WEIGHTS

Sheet Length	Dry Weight	Measurements (units)		
		ft	in	m
1375 mm	22.37 kg	4' 6"	54	1.375
1520 mm	24.80 kg	5'	60	1.52
1675 mm	27.29 kg	5' 6"	66	1.675
1825 mm	29.81 kg	6'	72	1.825
1975 mm	32.58 kg	6' 6"	78	1.975
2125 mm	34.70 kg	7'	84	2.125
2275 mm	37.31 kg	7' 6"	90	2.275
2440 mm	39.75 kg	8'	96	2.44
2600 mm	42.35 kg	8' 6"	102	2.6
2740 mm	44.64 kg	9'	108	2.74
2900 mm	47.27 kg	9' 6"	114	2.9
3050 mm	49.70 kg	10'	120	3.05



Health & Safety Data

TRADE NAME

Eurosix Profiled Sheets and Fittings

MANUFACTURER

Briarwood Products
Briarwood Business Park
Commerce Way
Somerset, UK, TA9 4AG

CERTIFICATION DETAILS

Conforms to European Standards EN 494 Class C1X
Carries BSI Quality Assured Certificate ISO 9002

NORMAL DRY DENSITY RANGE

1.4kpfm 3 Surface pH of sheets: 12

TRANSPORT AND WASTE DISPOSAL REQUIREMENTS

No special Requirements

INTENDED USE

Eurosix Sheets and Fittings are intended for external, semi exposed, and internal uses in roofing and cladding applications.

- When new and first installed in accordance with our recommendations, Eurosix sheets can be classified as a non-fragile Class C roof assembly in accordance with ACR[M]001.
- Once the roof has been completed and the netting/scaffolding removed if any subsequent access is required on the roof, the sheets should be treated as a fragile assembly.
- Always use a HSE recommended roof access system whenever required.
- Always fix sheets fully before moving on.
- To minimise dust, cut sheets with a handsaw or slow speed reciprocating power saw. The use of angle grinders is not recommended.
- Avoid deflecting a sheet whilst attempting to force a bearing.
- Do not step on the side lap corrugations.
- Where regular access is required to reach roof lights, ventilation and service ducts, properly constructed walkways should be provided within the design of the building.

PRODUCT APPEARANCE

Eurosix Sheeting is made exclusively with the following:

- Portland Cement
- Cellulose (Wood)
- Silica (Sand)
- Artificial Organic Fibres (Plastic)

HANDLING, PROCESSING AND USE PRECAUTIONS

Sheeting should be handled with care to avoid injury and placing unnecessary strain on handlers. Gloves should be worn.

EXPOSURE LIMITS

- A. Occupational total inhalable dust in mgm³ over 8 hours: 10mf/m³
- B. Standard respirable dust in mgm³ over hours 5mf/m³





HEALTH HAZARDS, PRECAUTIONS AND FIRST AID

INHALATION

HEALTH HAZARD

Acute overexposure to dust may cause mild irritation and inflammation of the respiratory tract and organs.

PRECAUTIONS

Use approved respiratory protective equipment when airborne dust is present. Dust extraction equipment is advisable when cutting with power tools.

FIRST AID

If irritation continues, move to fresh air. If conditions persist, seek medical advice.

EYE CONTACT

HEALTH HAZARD

Mild discomfort caused by dust.

PRECAUTIONS

Goggles should be worn when cutting or drilling.

FIRST AID

Flush with plenty of fresh water, seek medical advice if the condition persists.

INGESTION

HEALTH HAZARD

Ingestion of dust may cause mild discomfort.

PRECAUTIONS

Avoid ingestion by taking normal hygiene precautions. Use dust masks where airborne dust is present.

FIRST AID

Wash thoroughly with water.

SKIN CONTACT

HEALTH HAZARD

Prolonged contact may cause mild irritation.

PRECAUTIONS

Gloves should be worn when handling.

FIRST AID

Wash thoroughly with water.

All current Health & Safety guidelines must be adhered to at all times. Please contact our technical department for more.





Designing your roof

- Ventilation
- Exposure zones
- Fixing
- Vertical cladding
- Typical rooflight configurations
- Colour ranges

Ventilation systems

VENTILATION

Briarwood Products has exclusively designed a range of different ventilation systems in order to help provide the maximum ventilation into a building structure. Ventilation helps create a healthier environment for livestock with improved natural light, that reduces the risk of diseases and helps reduce heat stress from livestock and moisture build-up.

BENEFITS OF A VENTILATION SYSTEM

- Creates a healthier environment for livestock
- Reduces risk of disease such as pneumonia, mastitis and scours
- Improves natural light transmission into the structure
- Helps eradicate the build-up of smells from livestock
- Allows natural air to enter and condition the building

TYPES OF VENTILATION SYSTEMS

- Ventilated cranked ridges
- Raised curved ridges
- Open protected ridges
- Two piece adjustable ventilated ridges
- Fibre cement spaced roofing sheets
- Breathable roofs



Open ridge systems

OPEN PROTECTED RIDGE SYSTEMS

Efficient ventilation is important in the design of an agricultural building. The open protected ridge ventilation system is specifically designed for livestock buildings, as it supports animal welfare by reducing moisture levels which can carry bacteria and disease.

The open protected ridge ventilation system provides optimum ventilation at the apex of the ridge using the stack effect and is therefore particularly efficient at removing moisture saturated air from within the building.

As air flows up the outside slope of the roof it hits the upstand of the ridge deflecting the air upwards, creating negative (low) air pressure helping to draw the air through the opening at the apex of the roof between the top sheets.

This does not only help the ventilation of the internal airspace, but also the airflow blows away rainfall from the opening in the apex, and can help stop rain from entering the building.



OPEN UN-PROTECTED RIDGE SYSTEMS

An open un-protected ridge system has the same concept as an open protected ridge system, however with this, the weatherboard is removed therefore creating a higher volume of airflow out of your structure.

This is one of the preferred ridge systems for increasing ventilation out of your structure, especially if you are looking to house livestock in the building.

Whilst maximising the airflow out of the structure, it is recommended that if your design incorporates using an un-protected open ridge system, care must be taken on the internal layout. For example, animal bedding areas (such as cow cubicals) should not be placed directly underneath the ridge line otherwise the rainfall that may fall through the open area may ruin the bedding. On the other hand, it would be perfectly acceptable over a passage way.

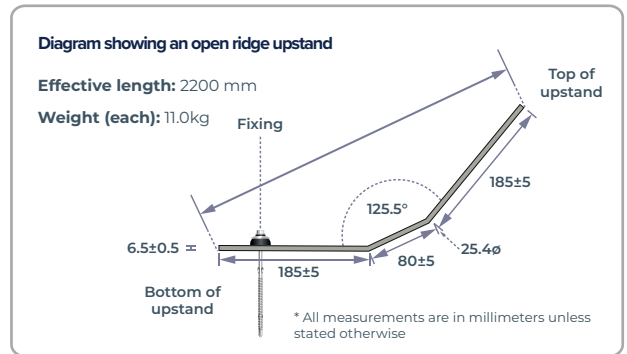

RECOMMENDED FIXING PROCEDURE

The critical factor to efficient open protected ridge ventilation is the air gap. In accordance with HSG 33 guidance, the open ridge should have a maximum gap of 300 mm, the ventilation gap labelled Y should be calculated by the number of animals that will be housed in the building, to a maximum gap of 250 mm. We recommend that you seek advice from our technical team to help calculate this for you.

The open ridge is protected by a fibre cement weatherboard unit 300 (W) x 2400 (L) mm bridged at 750 mm centres by galvanised metal straps manufactured to suit the pitch of the roof/width of airgap etc. The straps are fixed at an angle of 5° from the horizontal plane of the building and then bolted to the straps to form a protective cover.

The cover must be positioned at least 20 mm below the top of the upstands of the ridge pieces. Each unit is overlapped to the next along the right line of the roof approx 90 mm.

	Weight when laid
Open protected ridge system	15.22 Kg/m
Open un-protected ridge system	10.77 Kg/m

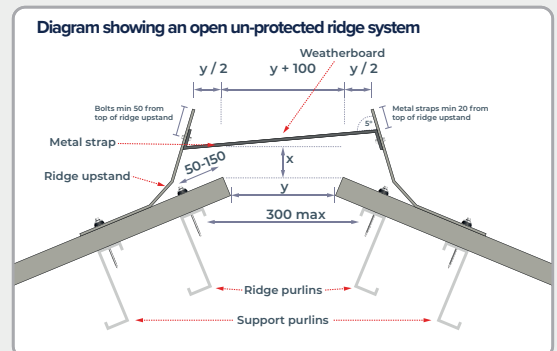
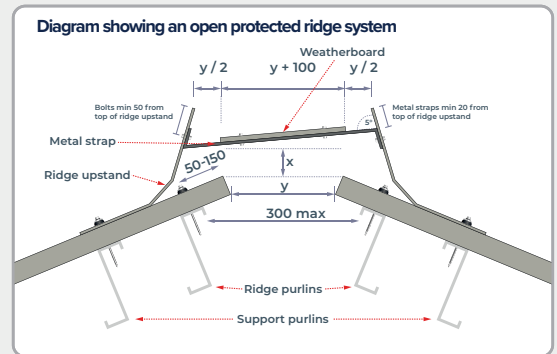

Raised curved ridges

WHAT IS A RAISED CURVED RIDGE?

Our raised curved ridge system has been designed to maximise ventilation into and out of a building. The curved ridge acts as an 'umbrella' shielding the building from direct rain whilst efficiently allowing fresh airflow.

- The raised curved ridge is an advantageous alternative to using an open protected ridge system, as it allows beneficial airflow, whilst protecting against risk of direct rainfall entering the ridge detail or livestock building itself.
- The system is flexible and the airflow can be adjusted to suit all building sizes by the height of the ridge
- The raised curved ridge is reinforced with strategically placed polypropylene strips which are fully integrated along the length of each corrugation.
- Calculation Y can be as wide as you would like because the curved raised ridge has reinforced polypropylene strips which increases the strength and impact resistance making it a non-fragile roofing sheet.

RECOMMENDED FIXING PROCEDURE

Two fixings per sheet in each purlin are required, these should be fixed through the first full corrugation next to side lap detail.

If the curved ridge run exceeds 45m movement joints will be required, as per standard recommendations.

In locations where the wind section forces are likely to exceed 2,000 N/sqm or the length of the roof slope exceeds 30m, please refer to current building regulations and procedures.

Please always follow our essential information regarding storage, handling, health and safety guidelines and fixing procedures.

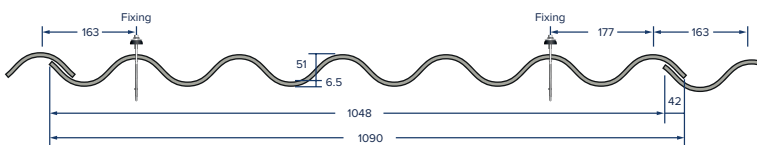

Girth	1400 mm
Maximum unsupported overhand	300 mm
Weight	23.5kg per linear metre of ridge
Radius	3000 mm

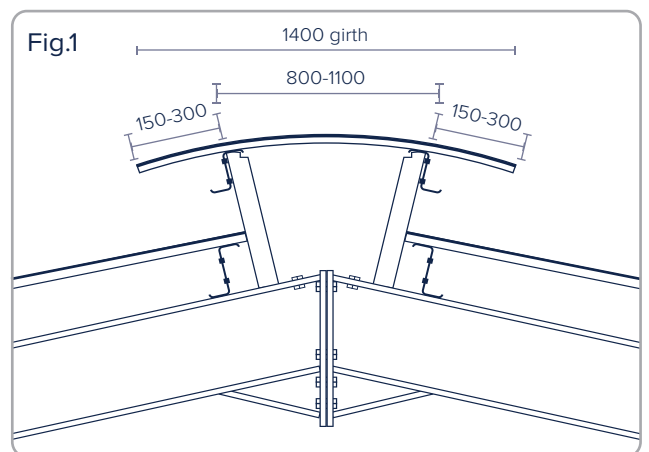

In Fig.1, A illustrates where the raised measurement will be dependent on the design and ventilation requirement of the building.

The stack effect

The stack effect is a naturally occurring method which helps ventilate buildings by sucking the warm dense air out from the building through the ridgeline. As the wind hits the slopes of the roof, it is deflected upwards due to the ridge upstand which then as the gust rises by, it creates a suction due to the low pressure air that is pulled out of the structure.

- A** The wind hitting the roof slopes
- B** The wind caused by **A** which is deflected from the ridge upstand creating a suction effect due to the winds crossing paths
- C** The dense warm air which has risen up and is sucked out as a direct result caused by **B**

This effect occurs on our open protected/un-protected ridge systems and raised curved ridge systems.

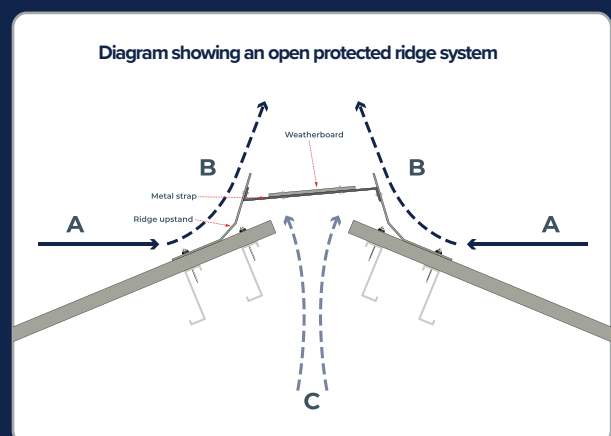

Ventilated ridges

CRANKED RIDGES

Designed specifically to work coherently alongside of our 6 inch profiled EUROSIX fibre cement sheets, we manufacture cranked ventilated ridges which are extremely easy to install and provides a simple way to allow ventilation into the building.

The EUROSIX range of cranked ventilated ridges are available in a variety of different sizes (see the chart below).

Both slopes of the roof must be sheeted starting at the same gable end and the corrugations must accurately align up and over both slopes of the roof.

It is essential that the ridge and the top sheets are mitred. Fix the ridge in exactly the same way as the sheets, and ensure the fasteners are a minimum of 100 mm from the tail end of the ridge.

When placing our ventilated ridges, there must always be one close fitting ridge on the start of the ridge line and one close fitting ridge on the end of the ridgeline.

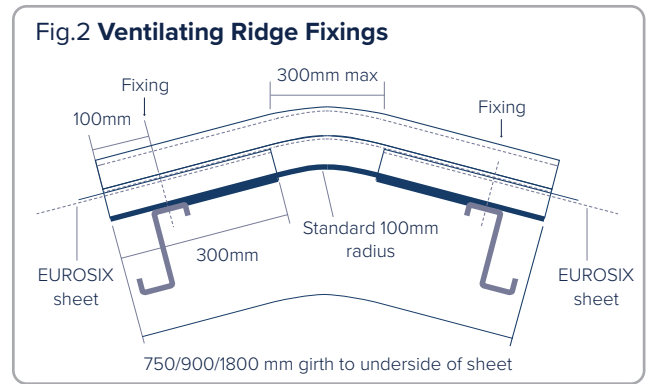

Each ventilated close fitting cranked crown ridge provides a free air space of approximately 68,360mm².

STOCKED RIDGE DEGREES

GIRTH (mm)	5°	7.5°	10°	12.5°	15°	17.5°	20°	22.5°
750 mm	✗	✗	✗	✓	✓	✗	✗	✗
900 mm	✓	✓	✓	✓	✓	✓	✓	✓
1800 mm	✗	✗	✓	✓	✓	✓	✗	✓

PURLIN SETTING OUT

All 750 mm and 900 mm cranked ridges (both closed and ventilated) must overlap the EUROSIX straight sheet by 300 mm (this creates a non fragile ridge detail).

If the sheets have to be laid with 300 mm laps because of the exposure rating, use the smaller dimension,

For anyone using a EUROSIX ridge with a 750 mm girth on roofs with a pitch of 12.5° or 15°, a 300 mm overlap will encroach on the curved part of the ridge, this is correct. However to ensure no damage occurs, use 8 mm butyl strips as a spacer between the ridge and the sheet.

PITCH A	PURLIN DEPTH B		DIMENSION C FOR 900 MM RIDGES	
	B = 75	B = 125	B = 175	B = 225
5°	193	189	185	181
7.5°	191	184	177	171
10°	187 - 337	178 - 328	170 - 320	161 - 311
12.5°	184 - 334	173 - 323	162 - 312	151 - 301
15°	182 - 332	168 - 318	155 - 305	142 - 292
17.5°	179 - 329	164 - 314	148 - 298	132 - 282
22.5°	175 - 325	155 - 305	134 - 284	113 - 263

PITCH A	PURLIN DEPTH B		DIMENSION C FOR 750 MM RIDGES	
	B = 75	B = 125	B = 175	B = 225
12.5°	109 - 259	98 - 248	87 - 237	76 - 226
15°	107 - 257	93 - 243	80 - 230	67 - 217



Spaced roofs

Briarwood are the only company who stock all lengths of fibre cement spaced roofing sheets which are ready to be delivered nationwide direct to site within just a few days.

When you are designing a structure which is going to be used for livestock housing, then it is important to ensure that your structure has the best ventilation achievable. We would recommend that you should incorporate our fibre cement spaced sheets in your design to help maximise all ventilation opportunities.

On some structures, very high levels of ventilation are required therefore these roofing sheets are a viable option to help cater for the free-flow of air throughout the structure.

Spaced fibre cement sheets should not be used in exposure zones where rain downfall and other harsh weather conditions may be detrimental to the contents inside of the structure.

Our fibre cement spaced sheets have the same properties and data as our standard EUROSIX fibre cement 6 inch profiled roofing sheets.

These spaced roofing sheets do not require mitring.

IMPORTANT INFORMATION

Overall width	1000 mm
Gap required	16 to 25 mm

Each fibre cement spaced roofing sheet provides a free air space of approximately 16-25000 mm²/m run air gap.

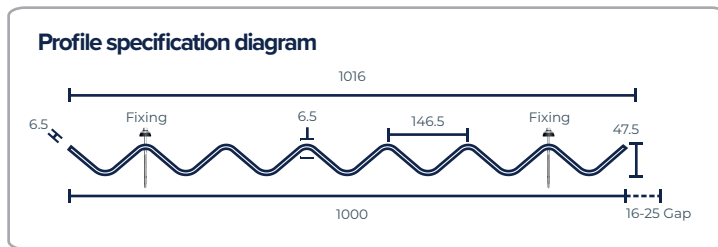

LENGTHS AND WEIGHTS

Sheet Length	Dry Weight	Measurements (units)		
		ft	in	m
1520 mm	24.80 kg	5'	60	1.52
1675 mm	27.29 kg	5' 6"	66	1.675
1825 mm	29.81 kg	6'	72	1.825
1975 mm	32.58 kg	6' 6"	78	1.975
2125 mm	34.70 kg	7'	84	2.125
2275 mm	37.31 kg	7' 6"	90	2.275
2440 mm	39.75 kg	8'	96	2.44
2600 mm	42.35 kg	8' 6"	102	2.6
2740 mm	44.64 kg	9'	108	2.74
2900 mm	47.27 kg	9' 6"	114	2.9
3050 mm	49.70 kg	10'	120	3.05



Breathing roofs

WHAT IS A BREATHING ROOF?

Creating a breathing roof is very simple and requires the installer to insert battens between courses of the fibre cement roofing sheets. Whilst a breathing roof is simple and effective, it helps to ventilate the structure where they have been designed for livestock.

KEY INFORMATION

- Breathing roofs are not recommended for roofs with a pitch under 12.5°
- Due to the timber battens being placed on the top part of the fibre cement sheeting, this will decrease the pitch of the sheet therefore making it differ to the overall roofs pitch
- Timber battens need to be preserved treated 50 x 25 mm timber
- Must be placed on the horizontal overlap of each course
- Purlins should be fixed at 1375 mm maximum centres
- The sheets must have a minimum end lap of 150 mm (should be increased to 300 mm to minimise weather penetration depending on your exposure rating)
- Minimises condensation
- Does not require the installer to mitre

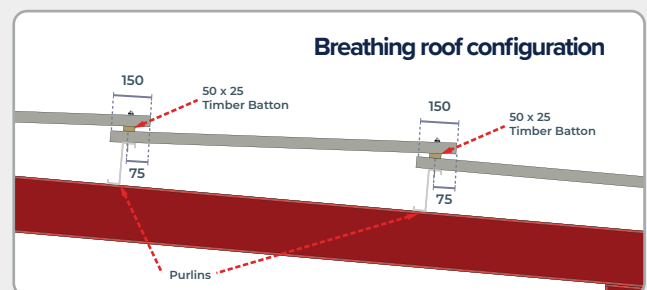
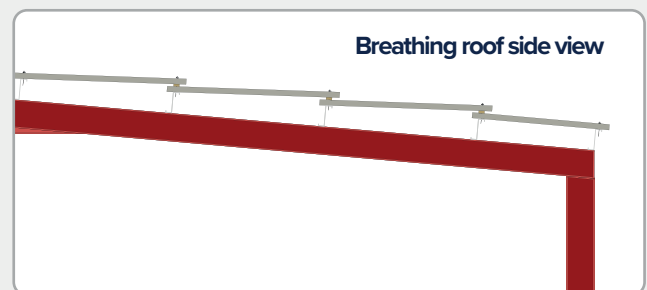

Wind loadings and lap treatments

It is important to understand the windloadings of where you are situated in the UK to ensure that your roofing conforms to the correct sealing requirements.

In order to determine the degree of exposure where your structure will be situated, please examine the map on the right.

For buildings that stand above their surroundings (meaning that they have no windshields such as trees or hills due to being in a large open area), Briarwood recommend that the structure must be considered subject to severe exposure.

To understand whether your structure is in an area where it may be subject to severe exposure, the following can help determine the surrounding environment and whether it would meet the classification:

- Near the coast
- On a hill where the structure rises above the general level of trees
- Towards a cliff-face
- On the side of a valley
- On high ground

Due to the sheeting being fixed through oversized holes in the crest corrugations, they can't be used in a stressed skin construction and can't be assumed to provide lateral restraint to the top flange of a purlin.

The maximum purlin deflection under total serviceability loads for steel structures should not exceed the following formula: $\frac{\text{purlin span}}{220}$

IMPORTANT NOTICE* For buildings which stand in surroundings where it is in open country with no windbreaks (especially including sites located near the coast, on the top of hills), Briarwood recommend that the specifier and designer contact us as their structure may be subject to severe exposure.

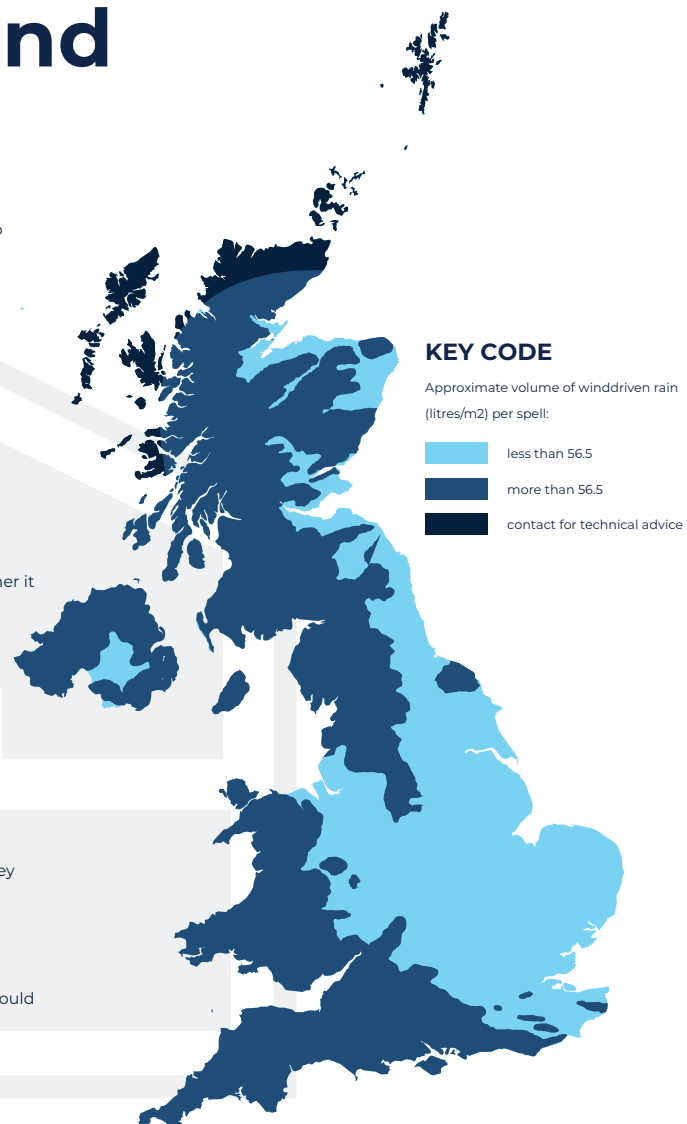

KEY CODE

Approximate volume of winddriven rain (litres/m²) per spell:

- less than 56.5
- more than 56.5
- contact for technical advice

Wind loading must be calculated in accordance with BS EN 1991 Eurocode 1: Actions on structures - Part 1-4: General actions - Wind actions.

PURLIN CENTRES

Briarwood recommend two fixings per sheet per purlin to support the fibre cement sheet to the structure. Our EUROSIX maximum purlin centres is 1375 mm for imposed loads of up to 1.89kN/m².

In some areas, wind suction loading may exceed the requirements set above in relation to wind exposure; please contact our technical department to help provide advice and guidance for reduced purlin spacing.

When using our fibre cement sheets to clad your structure, the maximum rail spacing should not exceed 1825 mm for imposed loads of up to 1.07kN/m².

It may be required to reduce the purlin rail spacings to facilitate extra fixings to deal with high wind loads.

IMPORTANT* There should be a maximum of 6 fixings per sheet (which will equvalate to 2 fixings per purlin per sheet).

If you need to reduce the purlin spacings, you must ensure that the sheet lengths only span across three purlins. If your sheet spans across more than 3 purlins, then you will need to use shorter lengthed sheets. By doing this, it will help with wind suction.



Lap treatments

WHAT IS LAP?

The lap is the measurement that describes what area and how much of one sheet overlaps onto another sheet at each end. This is split into the end lap, and the side lap.

ROOF PITCHES

The minimum pitch for our EUROSIX fibre cement sheeting is 5°.

When the fibre cement sheets are sloped on a pitch between 5° and 10°, it is recommended that the maximum slope length should be no more than 15 metres, and that they have double sealed end laps and single sealed side laps.

For roofs over a 10° pitch (and where there may be periods where large build-up of snow occurs), it is recommended that 300mm double sealed end laps and single sealed sidelaps are used.

SEALING THE ROOF SHEETS

Briarwood recommends to use a 8 mm diameter mastic butyl strip where the adhesive allows the overlapped fibre cement sheets to bond together whilst still allowing movement for the expansion of the fibre cement.

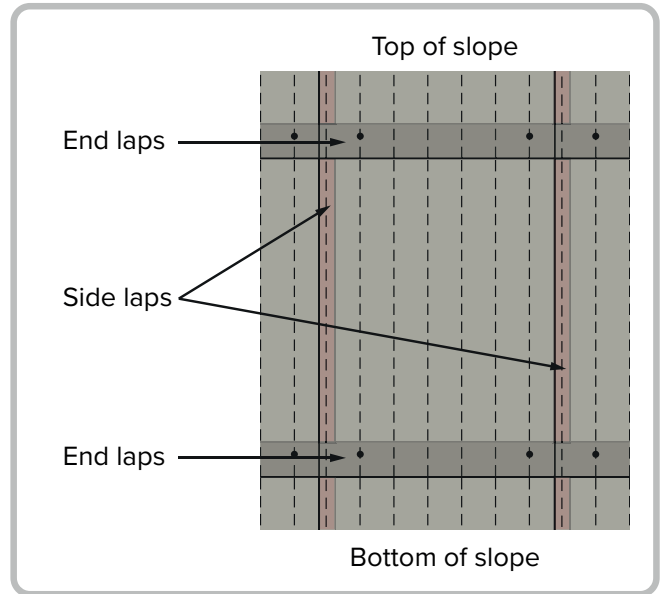

To find out whether you need to add seal your endlaps and sidelaps, please refer to the table shown below. To find out what type of site you are situated in, please look at page 20.

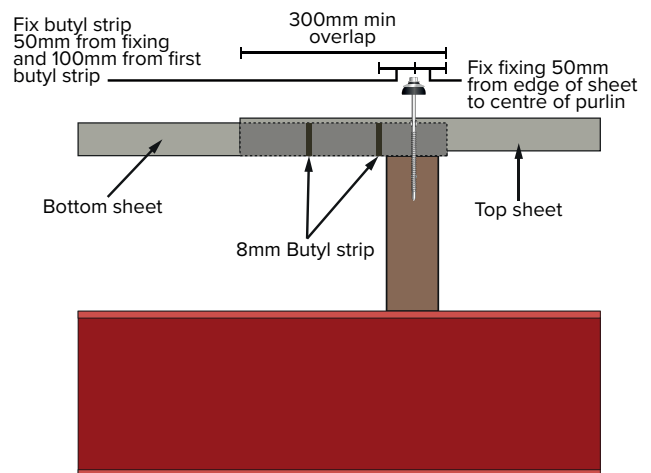
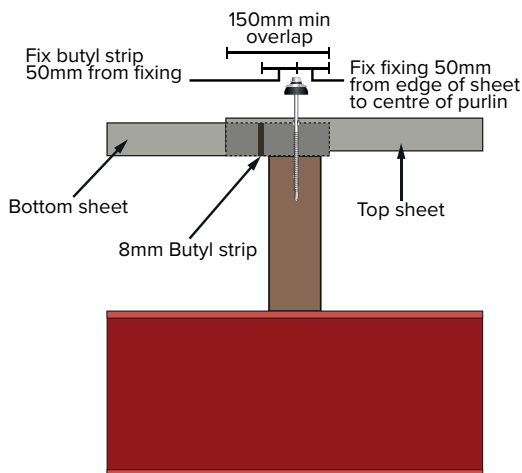

These diagrams show the end lap detail for a 15° roof pitch.

LAP AND SEAL TABLE

For ease, Briarwood have compiled two tables (which can be found on the right) to help reference alongside the UK map on the previous page in order to decipher what level of wind exposure your structure will be subject to.

Within this information, you will be able to find out what roof pitches require the different minimum end laps, as well as how the end laps and side laps must be treated to ensure that your structure is well designed when in an area in moderate or severe sites.

SHELTERED TO MODERATE SITES

LESS THAN 56.5 L/M2 OF WIND-DRIVEN RAIN PER SPELL

MINIMUM ROOF PITCH	≥22.5°	≥17.5°	≥15°	≥15°	≥10°	≥5°
Minimum end laps	150 mm	150 mm	300 mm	150 mm	150 mm	300 mm
End laps treatment	Unsealed	Unsealed	Unsealed	Sealed	Sealed	Double sealed
Side laps treatment	Unsealed	Unsealed	Unsealed	Unsealed	Sealed	Unsealed

MODERATE TO SEVERE SITES

MORE THAN 56.5 L/M2 OF WIND-DRIVEN RAIN PER SPELL

MINIMUM ROOF PITCH	≥22.5°	≥17.5°	≥15°	≥10°	≥5°
Minimum end laps	150 mm	150 mm	150 mm	300 mm	300 mm
End laps treatment	Unsealed	Sealed	Sealed	Sealed	Double sealed
Side laps treatment	Unsealed	Unsealed	Sealed	Sealed	Sealed



Setting out the roof

BEFORE CARRYING OUT THE WORK

Before all work is commenced, the structure must be checked to make sure that all supporting purlins and side rails are the correct level and spaced correctly according to the relevant purlin centres table. You must also ensure that all components are securely fixed and have the correct amount of torque.

LAYOUT OF THE SHEETING

The first and last sheets laid on any slope have no mitres and remain whole.

To correctly install, work one column at a time and lay the fibre cement sheets from the eaves to the ridge. Ensure that the prevailing wind direction matches the side lap.

An opposing column approach is taken for roofs that have a duo pitch and the sequence needed to ensure the cranked ridge fitting is correctly located can be found below.

Do not fit the roofing sheets on an apex roof where you start by laying down one full slope, and then onto the other slope. This will cause an issue when fitting the ridges because there may be a variation in the tolerances of the fibre cement sheeting and ridges. Doing this will increase the chance of the ridges not fitting correctly.

It is important that all of the sheets line up in straight lines up and over each slope of the roof to ensure that the ridge fittings can be fixed correctly.

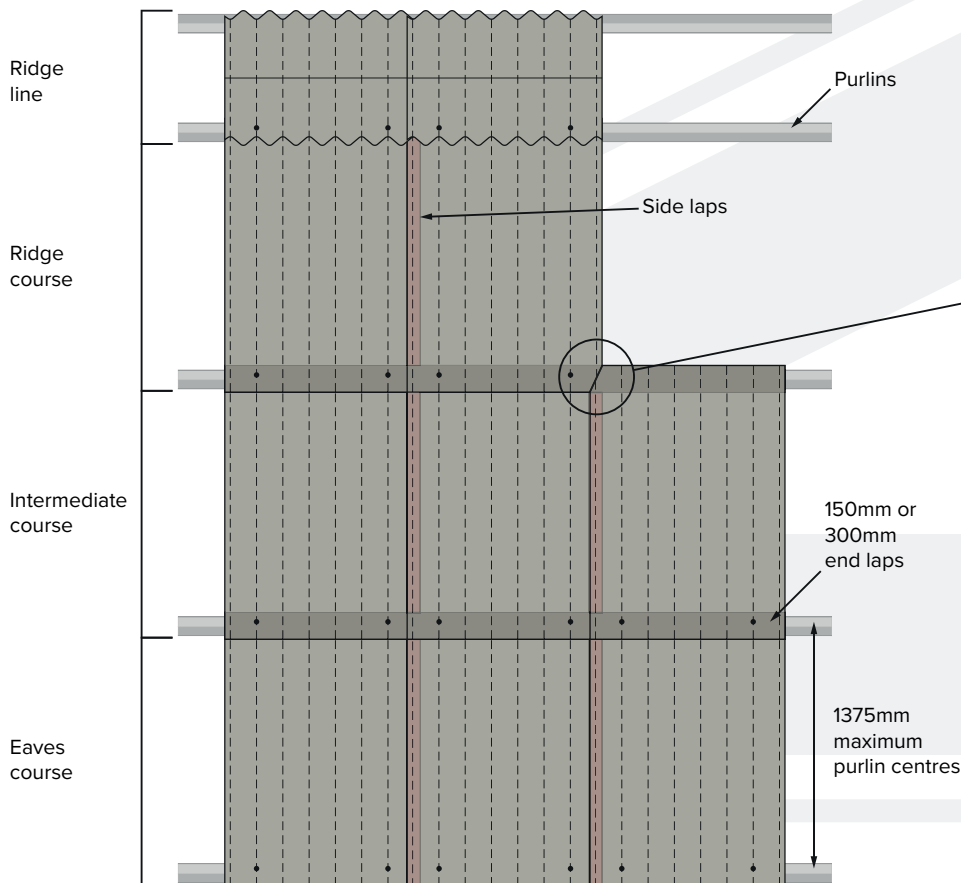
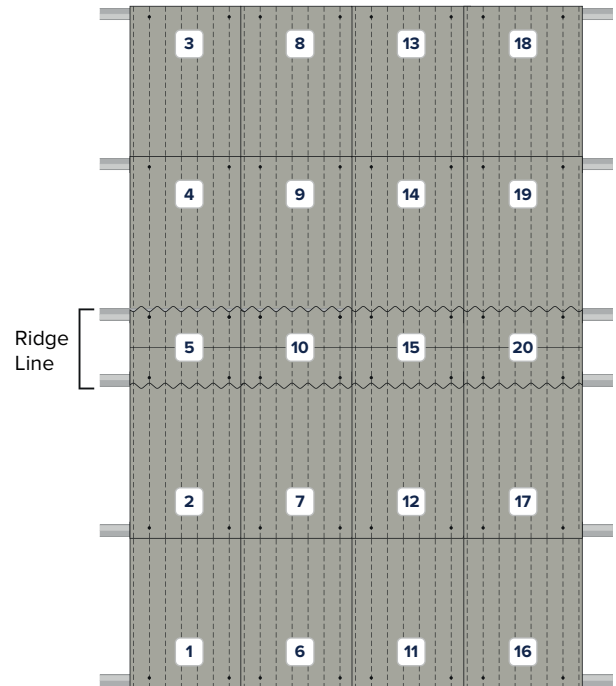
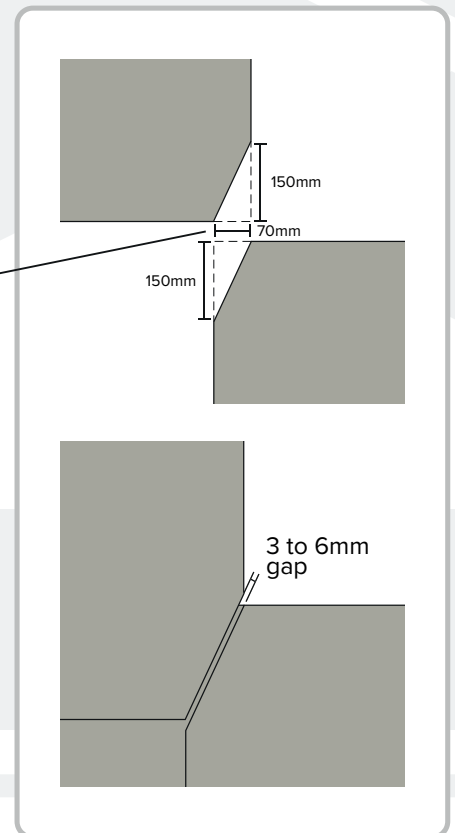

Diagram showing 1525mm EURO SIX fibre cement sheets

VISUAL REPRESENTATION OF MITRE



Mitring

To ensure that all fibre cement sheets lay in the same plane, it is required that two of the sheets at each junction is mitred at the corners which will avoid four layers of sheets stacking.

The mitres should be cut 150 mm (or up to 300 mm depending on the overlap) up the vertical edge of the corner, and then 70 mm along the horizontal edge.

Briarwood recommend that the gap between the mitres should be 3 to 6 mm.

The mitred joint is covered on the top and the bottom by the two other fibre cement sheets which allows the sheets to be fixed ensuring that the product is weatherproof and unseen.

IMPORTANT RULES

DO NOT MITRE ON THE ROOF

Prior to the fibre cement sheeting being raised onto the roof, you must always ensure that the layout has been chosen and that the appropriate sheets have been mitred on the ground level with no other product on the underneath. By mitring on the ground level on an even surface (such as a bench) and with no product underneath, this eliminates the chance of damaging other products and/or accidentally mitring the layered sheets once installed. Another primary reason on why you would not mitre on the roof is because this stops the dust and lime bloom from spreading across the sheets; this is the main cause for efflorescence to occur on the roofing sheets. If you mitre not following our guidance, it will increase the chance of potential damage and faults occurring which will invalidate any warranties and guarantees.

USE THE CORRECT EQUIPMENT

Briarwood recommend the use of a reciprocating saw in order to mitre the fibre cement sheets. We do not recommend that you use a handsaw or angle grinder because of the pressure which can build up whilst cutting through the sheet.

SHEET OVERLAPPING

To reduce the overlapping of four roof sheets, the corners of two must be mitred. The angle and size of the mitre is governed by the profile of the sheet and the end and side lap dimensions. It is recommended that a good quality butyl mastic strip is involved in joining the overlapping sheets to provide a weathertight seal.

MITRING LAYOUTS

For guidance on mitring for single and double slope roofs, see the images on this page to reference on how the mitring layout would appear.

For a double slope roof with adjustable ridges, one slope must be laid left to right and the other must be laid right to left.

Please bear in mind that when cranked crown ridges are used on the structure, both top sheets on either side of the slope must be mitred (as well as the cranked crowns).

For structures using 2 piece adjustable ridges, the top sheets on either side of the slopes and ridges must not be mitred.

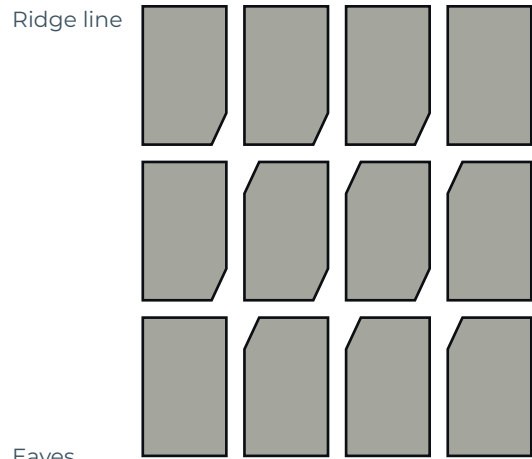

Lay left to right →

Mitres must be on the opposite hand when laying right to left

This mitring plan is designed for a mono pitch roof.

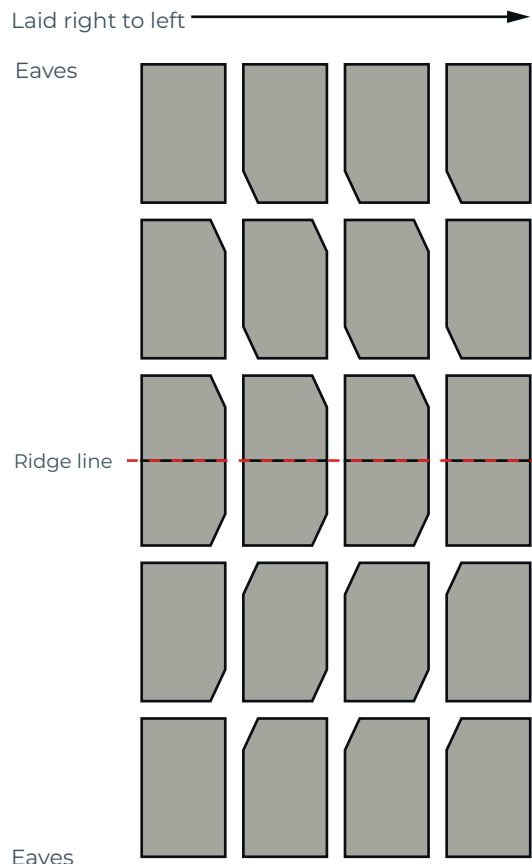

Laid right to left →

Eaves

Ridge line

Eaves

Eaves

Ridge line

Eaves

Eaves

Ridge line

Eaves

Eaves

Ridge line

Eaves

Eaves

Ridge line

Eaves

Eaves

Ridge line

Eaves

Eaves

Ridge line

Eaves

Eaves

Ridge line

Eaves

Eaves

Ridge line

Eaves

Eaves

Ridge line

Eaves

Poor mitring accounts for 95% of all roof leaks after installation, it is therefore paramount that the mitring process occurs and follows suit according to our advice and guidance set out by Briarwood.



Fixing

All fibre cement sheeting should be fixed accordingly to the structure inline with the BS 8219 standard.

When fixing a fibre cement roof sheet onto a structure, there must only ever be two fixings per sheet per purlin. There should only ever be a maximum of 6 fixings per sheet because then this would account for 2 fixings per purlin per sheet. If the fibre cement sheets spans more than three purlins, we recommend that you use smaller lengths and span only two purlin spaces maximum.

Depending on the type of purlin used on the structure will also depend on what type of fixing you use; therefore this must be recognised at the early stages of the design of the structure.

Choosing the right fixing at the start is important to avoid the chance of leaks, product failure and corrosion.

Fixings must not be less than 50 mm from the edge of any fibre cement product

If you would like to learn more information about the fixings which you have chosen to use to secure the fibre cement sheeting onto the purlins, please contact our technical office.



TOP-FIX/SELF-TAPPING

It is recommended that a self-drilling top-fix screw is adopted. This simple operation offers a fast, low cost fixing solution. Using the correct fixing with reamer wings on the shank, you are creating the perfect and ideal fixing environment. If the steel top fixings are used (without reamer wings), the hole must be pre-drilled at least 2 mm larger than the fixing diameter. These are available for timber, light section and heavy section purlins.

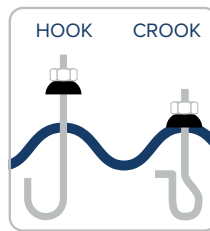

HOOK AND CROOK BOLTS

Hook and crook bolts are commonly used to secure sheets. Clearance holes should be 2 mm larger than the fixing, and must be pre-drilled to accept the fixing. The appropriate washer must be used to seal the operation to ensure that the fixing keeps the hole watertight and weathertight.

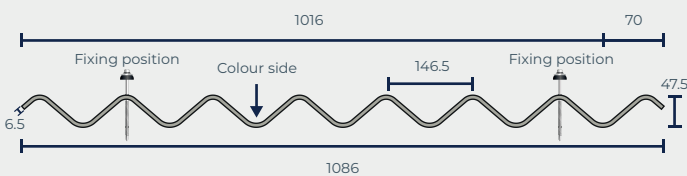

FIXING POSITION

The diagram shows specifically the recommended fixing positions. Never fix through side lap detail, always through first full corrugation, as per the diagram.

FASTENER SIZES

PURLIN TYPE	LENGTH	DIAMETER
TIMBER	130 mm	6.5 mm
TIMBER	180 mm	6.5 mm
LIGHT SECTION	105 mm	6.5 mm
HEAVY SECTION	110 mm	6.5 mm



DON'T USE A HAMMER

Never hammer fixings through the roof sheet. This will invalidate the guarantee on the product because the fibre cement sheets will shatter under impact and subsequently allow water to penetrate the apparent fixing.

Briarwood recommend that you should always pre-drill where the desired fixings will go on the fibre cement sheets.



NEVER WALK ON THE SHEETS

Never walk directly on-top of the fibre cement sheets. When you install the fibre cement sheets or when it is necessary to get ontop of the structure, you must use crawling boards or ladders. It is never advisable to wear soft soled shoes and you must never walk on liner panels. Foot traffic on the sheets should be kept to a minimum (both on the laid and on the ground).

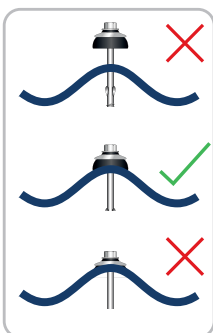

ENSURE THE FIXINGS ARE WEATHERTIGHT

To achieve a watertight and weathertight seal, it is important to confirm that the sealing washer is correctly tightened. This means that the fixing is not over-tight, nor is it too-loose. After a period of time when the material has settled, the fixings may need to be re-tightened with hand tools.

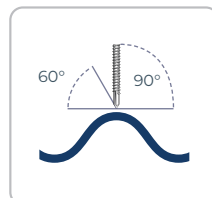

PRE-DRILLING FIXING HOLES

Using a tungsten carbide tipped drill at a 90° angle to the sheet, drill a hole 2 mm larger than the selected fixing diameter. Always drill at the 'apex corrugation' of the side of a profile. You must never fix a sheet in the 'valley' or a 'slope' of the profile.

Vertical cladding

TOPFIX METHOD

When using topfix fasteners to fix vertical sheeting, the weight of the sheets requires additional support to prevent the sheet from sagging down and overstressing both the sheet and the fasteners.

To support the base of each sheet, support clips that hook over the sheeting rails should be used.

Please reference diagram Fig.1

VALLEY FIXING METHOD

This is an alternative fixing method that does not require the support clips to fix the sheets through the valley corrugations.

The fasteners should be positioned (as per Fig.2) with a 2 mm oversize hole pre-drilled through the sheet.

Briarwood recommend the following fasteners which are suitable for valley fixing the EUROSIX fibre cement sheets:

- Hot rolled rails require SD12-T15-5.5 x 70 together with BAZ washers
- Cold rolled rails require SD3-T15-5.5 x 60 together with BAZ washers
- Timber rails require TDC-T-T16-6.3 x 76 together with BAZ washers (drill a pilot hole in the timber rail)

Fig.1

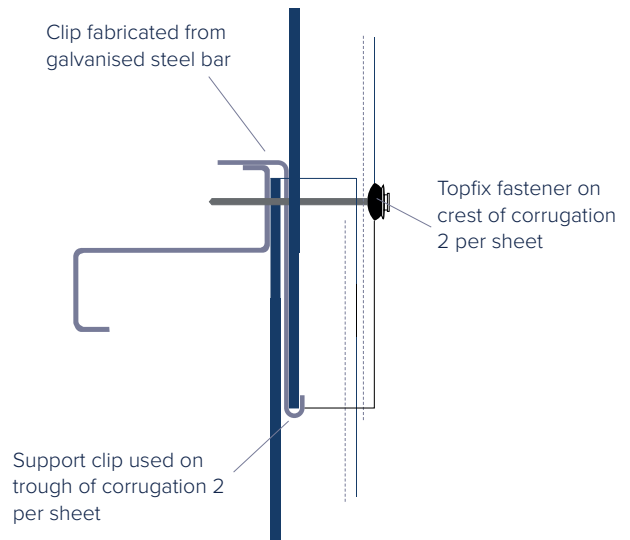
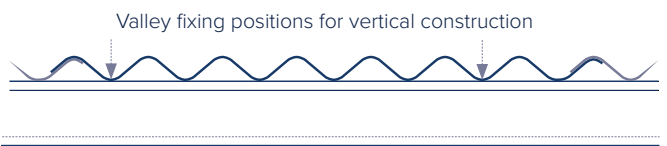

Fig.2



Colour range

At the start of our products life, it starts off in its natural form which is known as natural grey. Natural grey showcases our fibre cement sheets surface quality in its raw natural texture.

Each fibre cement sheet has its own character which is defined by an completely unique surface finish.

As well as being very cost effective because of the sheets being shown in its natural raw form, they are purposely designed to blend and fade from the day it is installed into the rural landscape.

From our decades of experience, our painted colour range has been handpicked to ensure it meets a wide range of design requirements in all sectors, including: agricultural, industrial, commercial and residential.

When our standard colour range is not enough and you require a different colour to which we would normally offer, we have an extended colour range readily available with fast turnarounds delivered directly to your site.

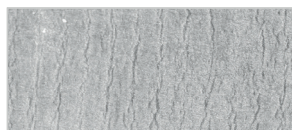

NATURAL GREY

MEADOWSCAPE FINISH

Our Meadowscape effect creates a beautiful time-worn look and feel and will bring character to any structure where fitted.



MEADOWSCAPE
SIMILAR TO ANTHRACITE
RAL 7016*

- The matte colour shade is a pigmented top layer of the fibre cement mix interfused during manufacture.
- Designed to reduce sunglare and reflection of naturally bright fibre cement sheets.
- Heavy variation in the colour and shade are purposely intended to give an enhanced appearance to the sheets and fittings*
- It is designed to blend and fade from the day it is installed into the rural landscape.
- Meadowscape is expected to lighten and mature over time.

STANDARD COLOUR RANGE

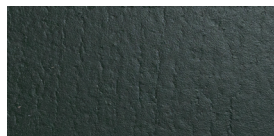

JUNIPER GREEN
BS 12-B-29



VAN DYKE BROWN
BS 08-B-29

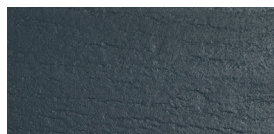

SLATE BLUE
BS 18-B-29

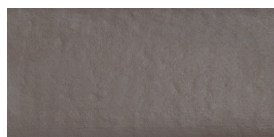

BEAVER BROWN
RAL 8025 | BS 08-B-25

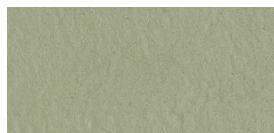

MOORLAND GREEN
RAL 100 60 20 | BS 12-B-21

EXTENDED COLOUR RANGE

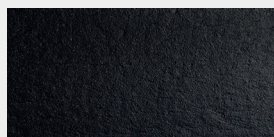

BLACK
RAL 9017 | BS 00-E-53

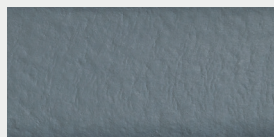

GUN METAL GREY
RAL 7031 | BS-B-25



CLOUD GREY
RAL 7038 | BS 10-A-05

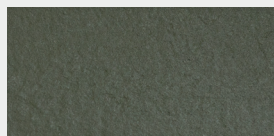

OLIVE GREEN
RAL 6003 | BS 12-B-27

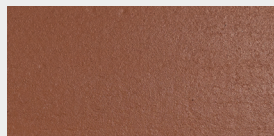

TAWNY/TILE RED
RAL 8004 | NCS 4040-Y70R



RUSSET MID BROWN
RAL 8012 | BS 04-C-39

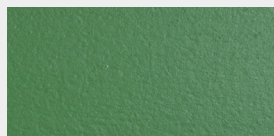

REED GREEN
RAL 6010

DISCLAIMER

We have reproduced this colour range document as accurately as printing will allow. To show the colours in the best way possible, we have taken a photo directly above in an equally-lit environment to get the best representation possible. We offer the ability to send colour samples for all of the colours in this document, so please ensure that you request a sample to get the best result possible and to match your exact expectation.

Typical GRP rooflight configurations

Briarwood supply a range of GRP Rooflight (translucent) which offer efficient natural light into any building. When fixed in conjunction with our EUROSIX fibre cement sheeting, the GRP rooflights will not require any mitre cuts.

LAP LOCKS

It is advisable to use weatherproof caps, and washers where possible, that are a distinctly different colour to the fixing of the rest of the roof. Conventionally, red caps are used for rooflights. Laplocks are used to fix the GRP to the fibre cement sheeting between the purlin lines.

RECOMMENDED CONFIGURATIONS

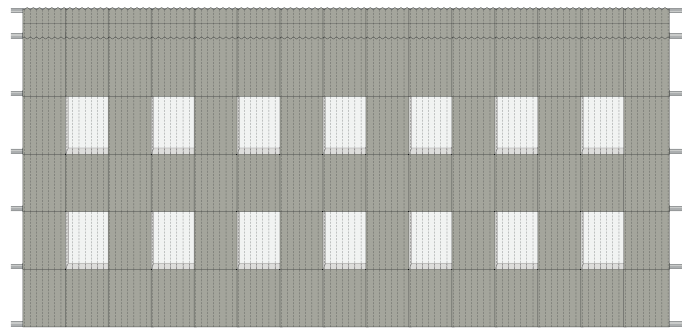
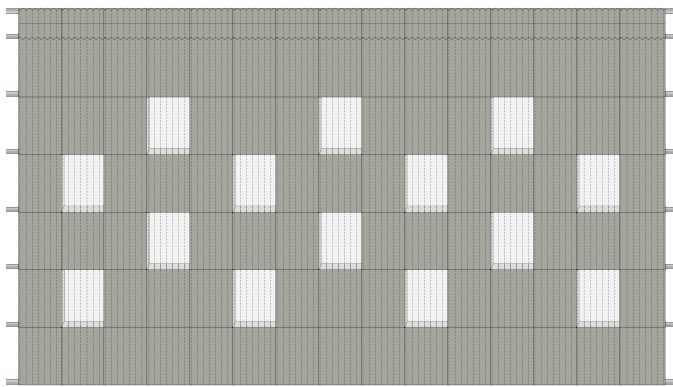

ADVANTAGES

- Good light transmission
- Easy installation
- 10 year guarantee

TECHNICAL DATA

Material	2.44kg/m2 GRP 8oz
Lengths	1525, 1675, 1830, 2130, 2440, 2740, 2900, 3050 mm
Fire rating	SAB Class 3
Fragility	Non-fragile Class C to ACR(M) 001: 2014 when fully fixed

INSTALLING ROOFLIGHTS

GRP rooflights should be fixed through every corrugation apart from the side lap corrugations, using the same fasteners as for the EUROSIX sheets.

Fixing positions of GRP rooflights should be seen through the peak of every corrugation which are sat directly above purlin lines (except side lap corrugations), and the purlin line where the GRP rooflight slides under the higher sheeting row.

Holes should be drilled 2 mm oversize. Self sealing fasteners with synthetic rubber shank (lap locks) or seam bolts and washers with a wide bearing, should be used at 300-400 mm centres for side stitching to the adjacent sheet where GRP sits above the fibre cement sheet.

End and side laps should be fixed using 8 mm diameter butyl strip sealant.

Foam fillers can be used to support GRP under central purlins.

GRP rooflights should never be used on the eaves or ridge row of sheets.

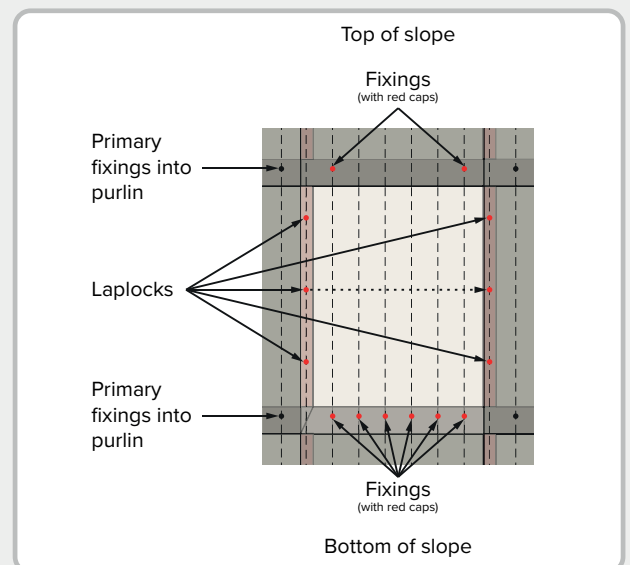



Accessories

- Bargeboards
- Ridges
- Finials
- Movement joints
- Apron flashing pieces
- Eaves detail
- Solar panels

Bargeboards

KEY INFORMATION

Ideally, bargeboards should be positioned so that their lap is directly below the end lap of the sheeting, with the top end of each bargeboard close to the tail end of the sheet in the course above.

Vergeline bargeboards are handed left or right when facing the gable end of the building with the socketed ends of roll top and vergeline bargeboards should point upslope.

The bargeboard lap should be immediately downslope of the sheet lap.

The sheeting should extend as far as possible under the bargeboard to ensure a weatherproof junction is provided. If lap sealant is required for the sheets, the sealant should also be applied to the bargeboards.

Allow 25 mm clearance between the wall and the bargeboard when the gable is brick or block. Fix both legs of the bargeboard at the purlin positions and intermediate fixings should be introduced as necessary to ensure that both wings of the bargeboards are fixed at 750 mm maximum centres.

OVERLAPS

BARGEBOARD TYPE	MIN OVERLAP
Plain wing	150 mm
Roll-top	Socketed
Vergeline	Socketed

It is common for installers to cut the unsocketed ends of the bargeboards to ensure a flush fit when carrying out the installation.



PLAIN WING UNSOCKETED AND UNIVERSAL

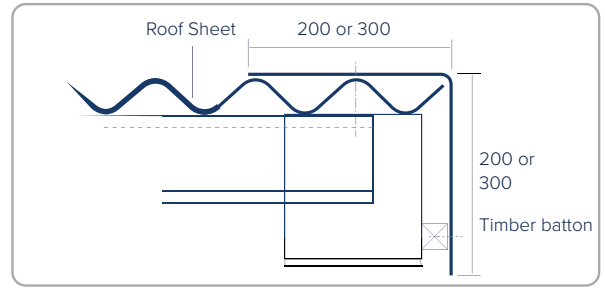

ROLL-TOP SOCKETED AND UNIVERSAL

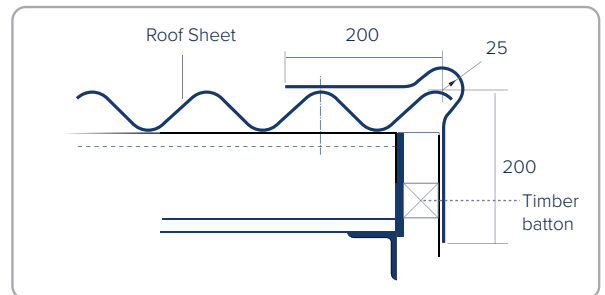

VERGELINE SOCKETED AND HANDED

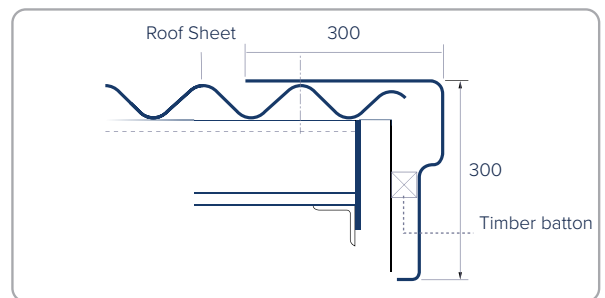

No fixing should be within 50 mm of any edge of the bargeboard. The timber battons will differ in sizes depending on the measurement obtained whilst measuring from the surface of the wall, to the bargeboard itself.

PLAIN WING

GIRTH	200 x 200 mm	300 x 300 mm
1800 mm	✓	✓
2440 mm	✓	✓
3050 mm	✓	✓

CRANKED PLAIN WING

WINGS	200 x 200 mm								300 x 300 mm							
	5°	7.5°	10°	12.5°	15°	17.5°	20°	22.5°	5°	7.5°	10°	12.5°	15°	17.5°	20°	22.5°
1300 mm	✓	✓	✓	✓	✓	✓	✓	✓	✗	✗	✓	✓	✓	✓	✗	✓
2200 mm	✓	✓	✓	✓	✓	✓	✓	✓	✗	✗	✓	✓	✗	✗	✗	✗

ROLL-TOP

GIRTH	200 x 200 mm	300 x 300 mm
1800 mm	✓	✗
2440 mm	✓	✗
3050 mm	✓	✗

CRANKED ROLL-TOP

WINGS	200 x 200 mm								300 x 300 mm							
	5°	7.5°	10°	12.5°	15°	17.5°	20°	22.5°	5°	7.5°	10°	12.5°	15°	17.5°	20°	22.5°
1300 mm	✓	✓	✓	✓	✓	✓	✓	✓	✗	✗	✗	✗	✗	✗	✗	✗
2200 mm	✓	✓	✓	✓	✓	✓	✓	✓	✗	✗	✗	✗	✗	✗	✗	✗

VERGELINE

LEFT & RIGHT HANDED

GIRTH	200 x 200 mm	300 x 300 mm
1800 mm	✗	✓
2440 mm	✗	✓
3050 mm	✗	✓

CRANKED VERGELINE

WINGS	200 x 200 mm								300 x 300 mm							
	5°	7.5°	10°	12.5°	15°	17.5°	20°	22.5°	5°	7.5°	10°	12.5°	15°	17.5°	20°	22.5°
1300 mm	✗	✗	✗	✗	✗	✗	✗	✗	✗	✗	✓	✓	✓	✓	✗	✓
2200 mm	✗	✗	✗	✗	✗	✗	✗	✗	✗	✗	✗	✗	✗	✗	✗	✗



Close fitting one piece ridges

Briarwood manufacture one piece close fitting ridges (also known as cranked crown ridges) which are designed to seamlessly overlap and cover the apex of any roofing structure.

Our close fitting one piece ridges are manufactured in pitches of 5° to 22.5° in 2.5° increments. Not only do we make them in a variety of different degrees, but we also offer 3 different girth lengths consisting of 750, 900 and 1800 mm.

When laying down these ridges, you must ensure that both the ridges and the sheets on either slope align correctly and sealed appropriately to create a watertight and weathertight seal.

The fixings should not be fixed less than 100 mm from the ends of the close fitting ridges therefore the ridge purlins will need to be positioned accordingly.

STOCKED RIDGE DEGREES

GIRTH (mm)	5°	7.5°	10°	12.5°	15°	17.5°	20°	22.5°
750 mm	✗	✗	✗	✓	✓	✗	✗	✗
900 mm	✓	✓	✓	✓	✓	✓	✓	✓
1800 mm	✗	✗	✓	✓	✓	✓	✗	✓

Fig.1 Closed Ridge Fixings

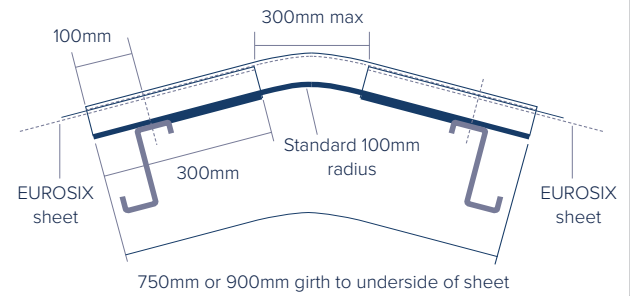

PITCH HELPER

ROOF PITCHES

CLOSE FITTING RIDGE PITCH	FROM	FROM
5°	5°	5.75°
7.5°	6°	8.25°
10°	8.5°	10.75°
12.5°	11°	13.25°
15°	13.5°	15.75°
17.5°	16°	18.25°
20°	18.5°	20.75°
22.5°	21°	23.25°

PURLIN SETTING OUT

All 750 mm and 900 mm cranked ridges (both closed and ventilated) must overlap the EURO-SIX sheet by 300 mm (this creates a non fragile ridge detail).

If the sheets have to be laid with 300 mm laps because of the exposure rating, use the smaller dimension,

For anyone using a EURO-SIX ridge with a 750 mm girth on roofs with a pitch of 12.5° or 15°, a 300 mm overlap will encroach on the curved part of the ridge, this is correct. However to ensure no damage occurs, use 8 mm butyl strips as a spacer between the ridge and the sheet.

PITCH A	PURLIN DEPTH B		DIMENSION C FOR 900 MM RIDGES	
	B = 75	B = 125	B = 175	B = 225
5°	193	189	185	181
7.5°	191	184	177	171
10°	187 - 337	178 - 328	170 - 320	161 - 311
12.5°	184 - 334	173 - 323	162 - 312	151 - 301
15°	182 - 332	168 - 318	155 - 305	142 - 292
17.5°	179 - 329	164 - 314	148 - 298	132 - 282
22.5°	175 - 325	155 - 305	134 - 284	113 - 263

PITCH A	PURLIN DEPTH B		DIMENSION C FOR 750 MM RIDGES	
	B = 75	B = 125	B = 175	B = 225
12.5°	109 - 259	98 - 248	87 - 237	76 - 226
15°	107 - 257	93 - 243	80 - 230	67 - 217

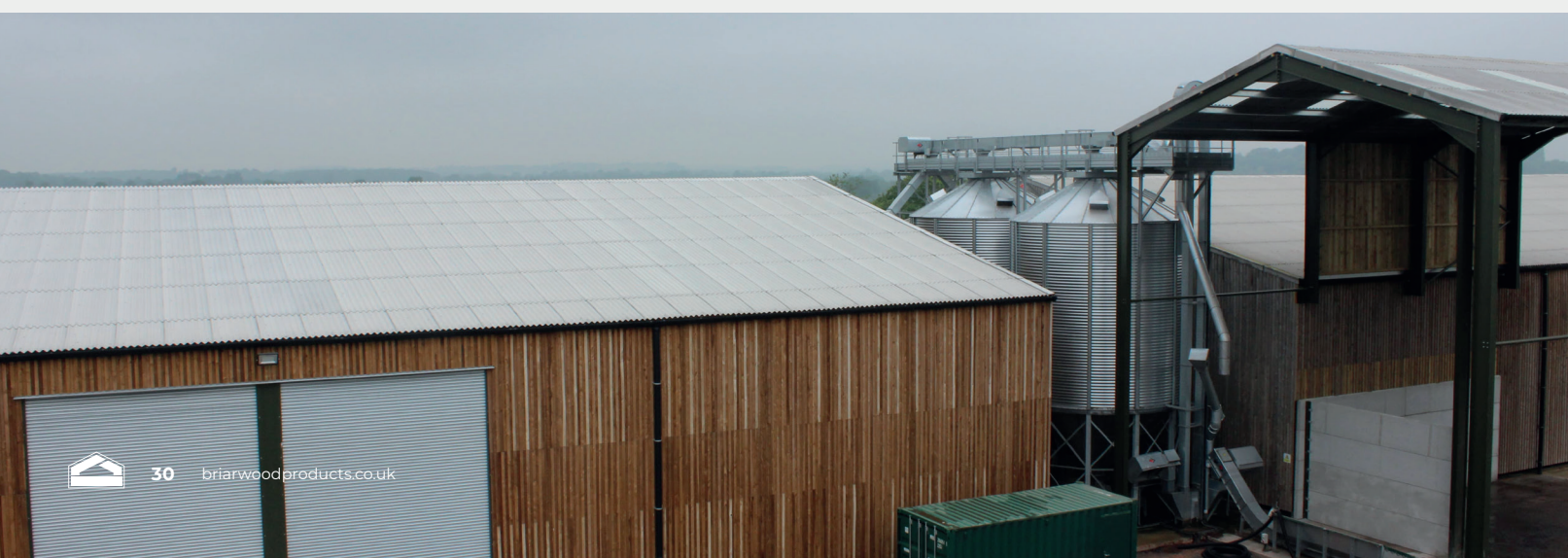

Adjustable two piece ridges

EUROSIX two piece adjustable ridges are suitable for roof pitches from 10° to 40°. Our EUROSIX two piece ridges cover a width of 1016 mm which is identical to the EUROSIX sheeting.

The ridges and sheets should be fixed into the top purlins.

TWO PIECE CLOSE FITTING RIDGE

Our fibre cement two piece close fitting ridge fits into corrugations of our EUROSIX sheeting and closes the gap at the ridge section.

TWO PIECE PLAIN WING RIDGE

Offers minimal ventilation and sits on top of the EUROSIX sheet corrugations.

TWO PIECE VENTILATING RIDGE

Suitable for continuous or part ventilation in combination with close fitting ridges. Continuous use requires a pair of close fitting ridges sited at each end of the run (start and finish of ridge detail).

IMPORTANT: These ridge types may not be suitable for buildings that require a large volume of ventilation or airflow. Please contact our technical department for specialist advice.

DIMENSION C FOR TWO PIECE RIDGE

PITCH (A)	PURLIN DEPTH (B)			
	75 mm	125 mm	175 mm	225 mm
10°	152	143	134	125
12.5°	146	135	124	113
15°	140	127	113	100
17.5°	134	118	102	87
22.5°	121	100	80	59
30°	100	71	42	-

Fig.1 Close fitting adjustable two piece ridge

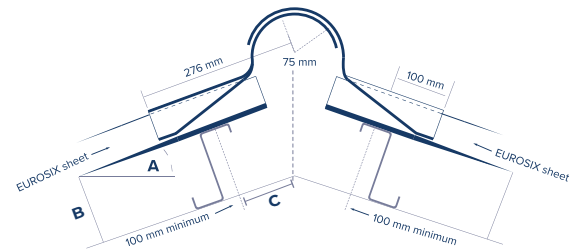

Fig.2 Plain wing adjustable two piece ridge

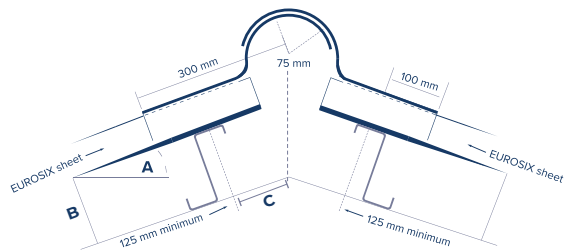
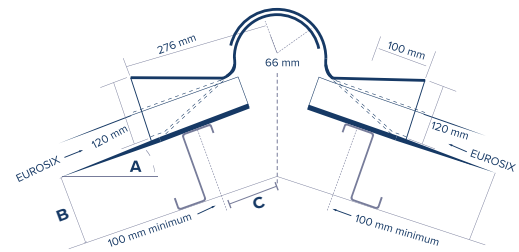

Fig.3 Ventilating adjustable two piece ridge



- Two piece ventilating ridges airspace allows 33,670mm² per pair
- Two piece plain wing ridge airspace allows 46,470mm² per pair

LOCATING TWO PIECE RIDGES

When locating two piece close fitting ridges, ensure the small roll under the ridge is sited on the slope sheeted left to right and the large roll is sited on the slope sheeted right to left. This ensures that the laps of the ridge align correctly with the laps of the sheets.

If the two piece close fitting ridges is sited the opposing way then the lap of the ridge must be offset by 1 corrugation from the lap of the sheets.

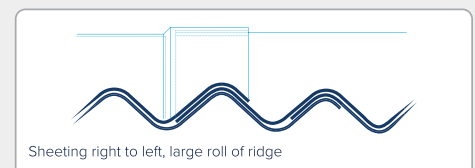
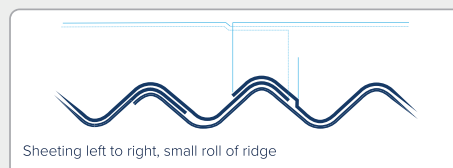
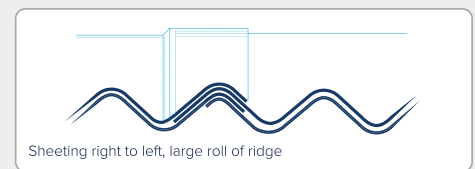
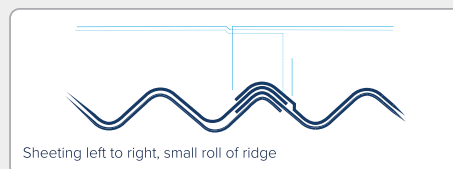

Finials

Briarwood offer EUROSIX finials to close the ridge at each gable end of the building.

The three key finials which we manufacture are:

- Disc finials
- Diamond finials
- Hooded finials

A finial can be used in conjunction with a two piece adjustable ridge with its purpose to close off the ridge at the apex.

It is important to note that the finials do not fit on the socketed end of any two piece ridge, and should be fixed onto the main body. Therefore we recommend that you offset the ridges as previously mentioned.

INSTALLING A DISC/DIAMOND FINIAL

To install, simply pre-drill a hole in the small roll of the end ridge piece and attach the finial using a nut or flat headed bolt. From there, the larger finial roll piece can be placed over the top to hide the fixing and the external corner pieces cut together to slot together behind the finial.

INSTALLING A HOODED FINIAL

Hooded finials should be used in combination with our roll-top bargeboards. Both sides of the slope should be finished with the bargeboards before the small roll of the hooded finial is placed in the desired position, followed by the large roll. Move the pieces around to ensure it has a good fit. Both sides should then be fixed to the centre of the purlin through the bargeboard and the final corrugation of the sheeting underneath. The finial should also then be fixed through the bargeboard into the framework on the side of the structure using a screw and washer.

DISC FINIAL

The disc finial must be seam bolted to the inner roll of the ridge before fitting the outer roll. This type of finial must be used in combination with plain wing and roll-top bargeboards (or where bargeboards are not being used).



DIAMOND FINIAL

The diamond finial is a one piece fixture and works in combination with both plain wing and vergeline bargeboards.



HOODED FINIAL

This type of finial should be used in combination with roll-top bargeboards.



Movement joints

In order to cope with thermal expansion and contraction, along with general movement on larger buildings, we recommend the use of EUROSIX movement joints on any long continuous lengths of roofing or vertical sheeting that extends over 45 metres in length.

COMPONENTS

- Straight movement joint pieces are 3000 mm in length
- Cranked ridge movement joint pieces have a girth of 1300 mm and come in 5°, 7.5, 10°, 12.5°, 15°, 17.5° and 22.5° degrees
- Movement joint stop ends
- Movement joint two piece ridge caps

APPLICATION

Movement joints are intended for use in long, continuous stretches of roofing or vertical sheeting, to accommodate thermal and other movements.

BS 8219 recommends that movement joints should be included in stretches of roofing and vertical sheeting on buildings exceeding 45 metres in length.

For buildings in which the temperature or humidity is higher than normal, or which are subjected to sudden changes in temperature, the movement joints may be required at closer centres than indicated.

KEY INFORMATION

EUROSIX fibre cement sheeting directly below the movement joint should be cut through the central valley of the corrugation in order to allow correct fitting of the movement joint. Each pair of half sheets are then set so they are 25-30 mm apart. It is essential that you do not simply space the sheets apart (please see Fig.1).

A movement joint is correctly positioned above the sheeting when the top end butts up to the corresponding bottom edge of the next upslope end lap sheet with a minimum end lap of 150 mm.

Purlins should be used to secure all segments of the movement joint in the same way as the fibre cement sheeting. One fixing line should be located at the centre of the movement joint on each purlin run.

Fixings must go through the gap created between the fibre cement sheeting (never fix movement joints through the sheets, always through the gap provided).

RECOMMENDED SPACINGS

LENGTH OF BUILDING	NUMBER OF MOVEMENT JOINTS
0-45m	0
45-75m	1
75-105m	2

Plus one extra movement joint for every additional 30m.

The installation of EUROSIX movement ridge pieces also requires a 25-30 mm gap to allow for movement (Fig.3)

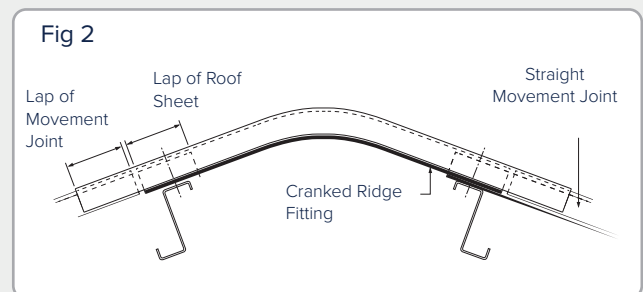
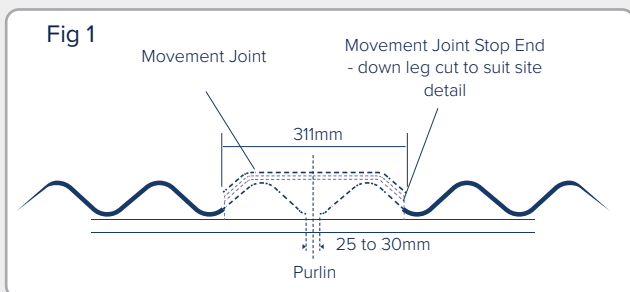

CRANKED MOVEMENT JOINTS

A 25-30 mm movement gap should be laid when laying a ridge piece (detailed in Fig. 1) and cover it with a cranked movement joint (range of pitches available), which will need to be fixed directly onto the ridge purlins. More details can be found in Fig.2.

When laying the straight movement joint, the top end should butt up to the overlay of the ridge piece. The cranked movement joint should be longer than the ridge piece allowing it to correctly overlap the straight movement joint. More details can be found in Fig.2.

When using movement joints with adjustable ridges (all types), see Fig.3.

MOVEMENT JOINT STOP ENDS

Intended to close the open end of a movement joint at the eaves detail, stop ends are made to fit over the sheeting into a straight movement joint. They should be fixed by bolting to the movement joint.

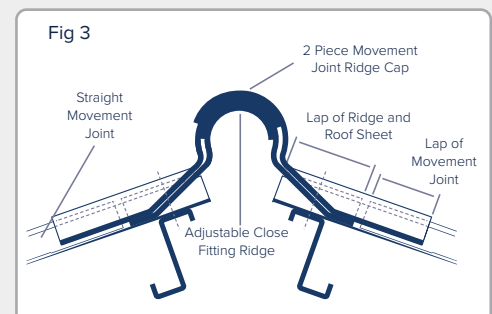

Apron flashings

To complete the detail finish at the top end of a mono pitch roof, where a slope of our EUROSIX fibre cement sheeting meets a vertical wall or vertical sheeting clad to an adjoining building, a EUROSIX apron flashing can be used along with a lead (or similar) flashing to seal this particular detail (Fig.1).

An apron flashing piece is profiled at one end to fit the fibre cement roof sheet and the other end has been manufactured to look like a wing.

In most scenarios, the apron flashing would be used to seamlessly align a mono pitch roof to the neighbouring wall or building.

Our apron flashing pieces are manufactured by standard with a left-handed socket meaning that they can be used on sheeting plaiced left to right or right to left, however this will determine by the position relative to the side lap of the sheeting.



FLASHING LAP

It is important to note that if working with sheeting from left to right, you should ensure that the apron flashing lap is in-line with the sheet lap (Fig.2).

However, if you are working from right to left, you should offset the apron flashing by one corrugation (Fig.3).

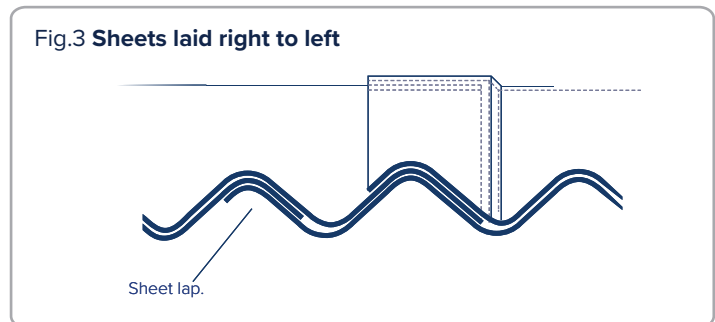
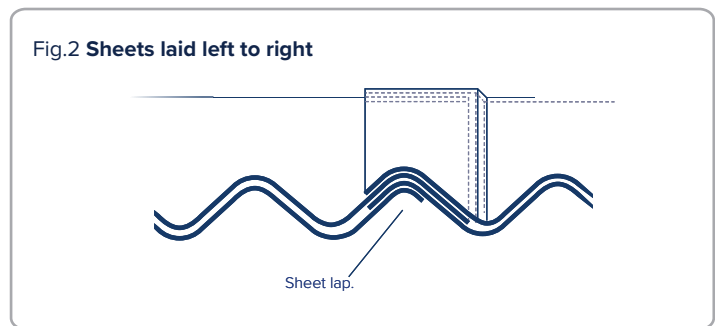
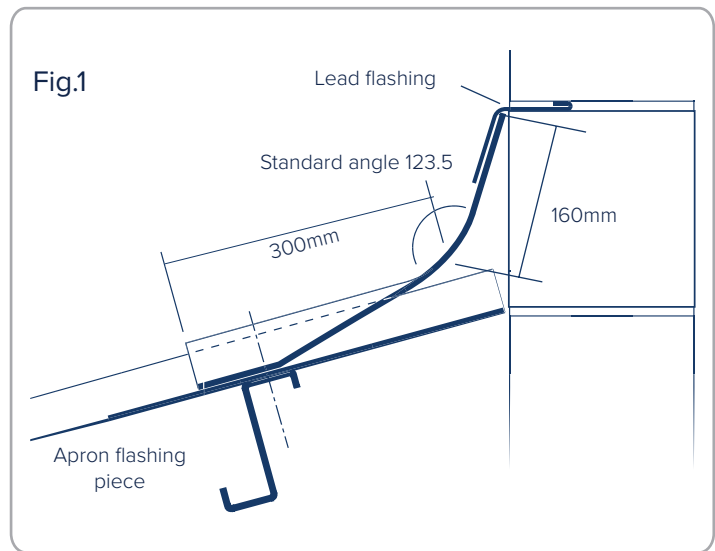

Eaves detail

If it should be required for you to close off the EUROSIX fibre cement sheeting corrugation gaps at the eave, the use of our EUROSIX eaves fillers and/or eaves closers is required.

Both give a 1016 mm cover width which gives the same coverage (when laid) as our fibre cement sheeting and can be used regardless of whether your sheets are laid right to left, or left to right giving them universal handling.

On the diagrams on the right, Fig.1 and Fig.2 demonstrate the correct installation with the lower corrugation of the eaves fillers designed to sit under the side lap corrugation of the EUROSIX sheets.

Sheet fasteners should be used to correctly fix the eaves fittings to the bottom purlin or eaves beam through the EUROSIX sheet.

EAVES CLOSURE PIECES

Designed to close the corrugation and insulate spaces at the eaves, the key benefit to having an eaves closure piece on your structure is because it forms a finish line at the downturn. This is especially useful in moderate to severe wind exposure areas because it creates a barrier against wind-driven rain.

Fig.1 Eaves Filler

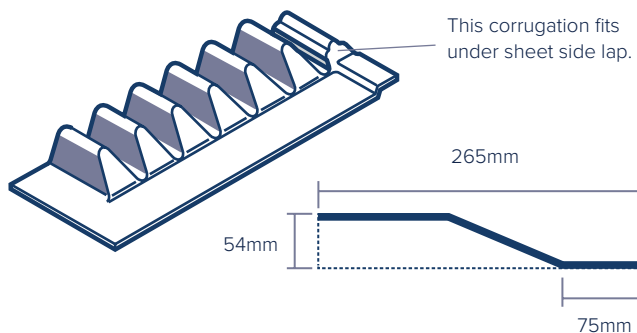
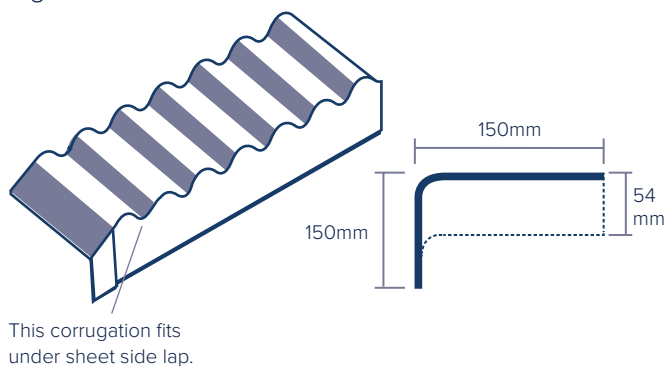

Fig.2 Eaves Closure



FOAM EAVE FILLERS

The cost effective solution to using fibre cement eave filler pieces is that you can use foam eave fillers. Using foam are extremely easy to apply and install. The use of an adhesive/mastic is recommended to achieve a permanent fix and prevent fillers being moved by birds or other outside influences.

PLASTIC EAVE FILLERS

Whilst both fibre cement eave filler pieces or foam fillers can be used, you can also use PVC/plastic eave fillers which carry the same advantages of our other eave fillers. Typically, plastic eave fillers are a preferred choice over foam fillers because of its durability. These eave details can be installed extremely easily and must be sealed using an adhesive/mastic to achieve a permanent fix. You can screw the plastic eave fillers directly to the eaves prior to installation of the fibre cement sheeting.

NOTE* both foam and plastic eave fillers are sold individually.

FOAM EAVE FILLER



PLASTIC EAVE FILLER



Solar panels

Briarwood supports every designer who chooses to place solar panel systems onto their structures and will help in every-shape possible to achieve the right data and give high-quality advice in regards to supporting the systems on our fibre cement sheeting.

There are various types of solar panel systems which can be installed above a fibre cement roofed structure. Some systems can affect the lifespan and durability of the fibre cement sheets due to the added stress from the extra imposed loading of the solar panel system.

KEY POINTS WHEN CHOOSING A SOLAR PANEL SYSTEM

- The maximum amount of fixings per purlin is two
- The solar panel system must never impose loading onto the corrugation peak
- Fibre cement sheets should not be walked on and the correct health and safety equipment should be used when installing the solar panel systems
- The purlins and building structure should be pre-designed to account for the additional loading of the solar panel system to ensure it conforms to building regulation standards
- Careful consideration should also be taken regarding the increase in build-up of snow and in any increase in wind loadings after the solar panel system has been installed
- There should never be any foot traffic on the roofing sheets when cleaning the solar panel system
- Design considerations should be made for access walkways for cleaning to prevent foot traffic from occurring
- There should never be any additional fixings through the fibre cement sheets into the purlins



Solar panel systems should only be used where the weight of the entire solar panel system is supported by the purlin and/or the buildings structure without adding any additional point-loading at any fixing position of the fibre cement roof sheet above the fixing tightness of a standard fibre cement roof.

Any restriction or compromises which weakens or changes the performance of the fibre cement roofing sheets may show as a product failure upon inspection and this will not be covered within guarantees or warranties.

Briarwood Products supports all designers who wish to include solar panel systems to work in harmony with our EUROSIX fibre cement sheeting and thank all of you for your interest in our products and services.

For more clarification on whether your proposed solar panel system is accepted and still leaves the fibre cement roofing sheets covered by our warranties/guarantees, please reach out to our technical office for final clarification.





Handling and storage

- General storage advice
- Handling advice

General storage advice

The fibre cement sheeting should be stored as close to the area where the work will be carried out.

All stacked fibre cement sheeting should be stored inside with the smooth site facing upwards. Where this may not be possible, it is important that the packaging is kept on the sheeting to eliminate the chance of water or outside condensation from entering the contents. (The fibre cement sheets will always arrive with the smooth side facing upwards.)

The packaging plastic wrapping covering the fibre cement sheeting has been designed to protect the product when in transit; it should be removed carefully and disposed of when the product is ready to be laid. Our delivery packaging is not designed to be an adequate cover when storing for long periods. The purpose of our delivery packaging is to ensure that the fibre cement sheeting is safely transported during the delivery stage.

Should any sheeting remain unused at the end of the working period, the sheets must be re-covered.

If the fibre cement sheeting will be retained in its packaging for more than 1 week, then the goods should be stored inside a building where they can be protected from extreme variations in temperature and moisture. Stacks of fibre cement sheets should not exceed 1200 mm in height (excluding the pallet height) if the sheeting is not on a solid and level concrete base. If the sheeting is on a level and solid concrete base, then the height of the stacked sheeting can go as high as 1500 mm.

Where stacks are to be laid on top of each other, there should be timber cross bearers placed no more than 1 metre apart from each other underneath the fibre cement sheeting. Please ensure that all timber cross bearers line up vertically.

STORING NATURAL GREY SHEETS

The natural grey fibre cement sheeting should be contained inside its original packaging plastic wrapping until the work which requires the sheets is ready to be carried out.

When the packaging has been opened (or where there may be damage to the original packaging plastic wrapping), the sheeting must be stored under cover. In most scenarios, the sheeting should be stored inside.

Allow the ability for air to circulate around the fibre cement sheeting stacks when storing the product indoors or underneath a protective cover (such as tarpaulin).

If several stacks are to be laid one on top of each other, timber cross bearers should be placed at 500 mm intervals up to a maximum height of 3000 mm. Please ensure that the ground is level and firm before stacking.

When rainwater, condensation and other harsh weather conditions make contact with the fibre cement sheets (particularly coloured sheets) whilst in storage, the ingress of moisture into the packs may cause efflorescence, staining, bowing during installation or permanent distortion.

This storage advice can be utilised across all of our manufactured fibre cement products.

DO NOT'S

- Do not store the fibre cement sheets in direct sunlight during Summer because of fluctuating temperatures. This can cause stress on the fibre cement sheeting which can ultimately lead to cracking around the edges.
- Plastic wrapping should not be removed from the fibre cement sheeting until the product is ready to be laid onto the proposed area of work.
- Do not walk on-top of the fibre cement sheeting stacks.

IMPORTANT* It is important that these guidelines are read through thoroughly because in the event of any damage whilst storing and handling the products, Briarwood Products will not be held responsible.

STORING COLOURED SHEETS

It is essential that any fibre cement sheeting which is part of our standard/extended colour range is stored under cover (such as inside of a building or under sheltered areas). Where this may not always be an option, the sheeting should be stored under a hard flexible material which does not allow for water to reach the products. A good example of a material suitable is tarpaulin.

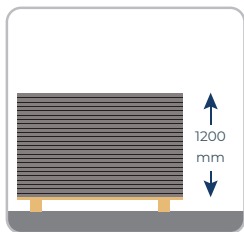

Recommended total height of fibre cement sheeting stacks.

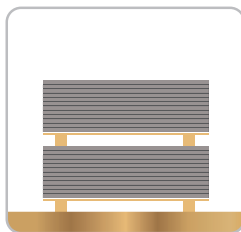
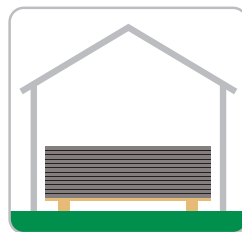
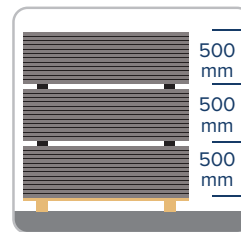

Diagram to show how the timber cross bearers should be placed.



Fibre cement stacks should be stored inside or undercover



There must be timber cross bearers in 500 mm intervals (up to 3000 mm)

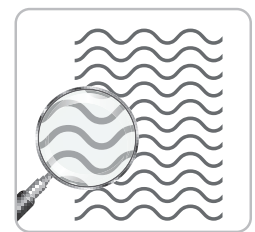

Inspect the fibre cement stacks on delivery regularly when in storage

Handling advice

Utilising our own in-house delivery network, all of our fibre cement products are delivered and offloaded using a vehicle-mounted forklifts meaning that we will be able to cater for the offload direct on your site.

However, where offload needs to be carried out using a crane, care should be taken to avoid damage to the edges of the fibre cement sheeting.

When using a crane to offload, rope slings must be used and not chains. The rope slings and over-width spreaders should eliminate the possibility of damaging the edge of the sheets.

It is important to note that the sheeting is particularly vulnerable during any period of transportation.

Always ensure that the forks of the loading machine are clean of any debris prior to lifting the fibre cement sheeting stacks; damage can occur if the forks are not cleaned which would harm and damage the bottom sheet of the stack.

HOW TO MOVE FIBRE CEMENT SHEETS

Whilst fibre cement is a very rigid and durable material, we would always recommend that the people involved in relocating the items should take good care.

- Never push, drag or slide the fibre cement sheeting from a stack or on any rough surface (such as when laid on concrete). The fibre cement sheeting should not be pushed, dragged or pulled over the purlins or other roof sheets.
- Always pick up the fibre cement sheeting one at-a-time from a stack and it is required that two people should maneuver the items at the same time.
- When maneuvering the fibre cement sheeting from one place to another, please take care and ensure that there is a clear pathway to prevent slipping or tripping.
- When hand-holding the fibre cement products, ensure that both members moving the goods are wearing gloves.
- When maneuvering the fibre cement sheeting, do not carry more than one length at a time because this can cause issues with health due to the increased load imposed on the carriers bodies.
- The fibre cement sheets must be held at the corners when being individually transported.
- It is important that when you place the first sheet down to form a new stack, you must ensure that there are timber cross bearers on the level and solid floor.

All current Health & Safety regulations should be adhered to at all times.

IMPORTANT* It is important that these guidelines are read through thoroughly because in the event of any damage whilst storing and handling the products, Briarwood Products will not be held responsible.

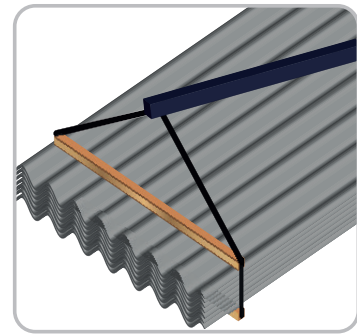

Use sling ropes (not chains) with over-width bearers when using a crane to offload.

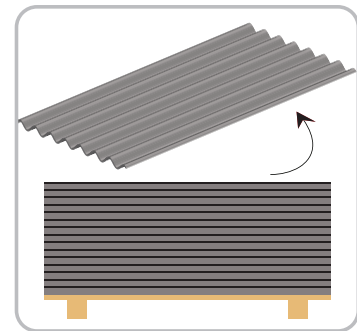

Fibre cement sheeting must be lifted one at a time and taken from the top-down.



Sheets must be hand-held off the stack and lifted by two people and held by the corners.



Never walk on the sheeting when they are stacked and when the sheeting has been installed.



Operating internationally

Briarwood - our most recognised brand combining our families farming expertise into a high-quality fibre cement sheet complimented by a range of comprehensive fittings and accessories.

Our business has evolved through multiple international acquisitions over the last 40 years, making Briarwood the largest British family owned fibre cement manufacturer in world.



Briarwood Products

Based in the United Kingdom

Briarwood Products headquarters houses over £7m worth of fibre cement products which is distributed all over the UK.

BRIARWOODPRODUCTS.CO.UK



Briarwood Supplies

Based in the United Kingdom

Briarwood Supplies is a builders merchant open to both the trade and public.

BRIARWOODSUPPLIES.CO.UK



Briarwood Landini

Based in Italy

Briarwood Landini is our manufacturing facility for all building materials, including all of our fibre cement products.

BRIARWOODLANDINI.CO.UK



Briarwood Tubex

Based in Spain

Briarwood Tubex, a pioneer in the manufacture of fibre cement plates and accessories where work is based on people, quality and 30 years of experience.

TUBEXSA.COM



BRIARWOOD
30 YEAR GUARANTEE
ON ALL EUROSIX SHEETS











Need it fast? No problem!

Any size order where you want it; when you want it.

Over 20 specialist vehicles delivering direct-to-site

The specialist vehicles as well as the exceptionally trained delivery team enables delivery to even the most challenging of sites. Many of our deliveries are made using articulated vehicles with truck mounted fork-lifts for efficient offloading. All our drivers are trained in farm deliveries and restricted access situations.



-  Artics, rigid vehicles and smaller trucks ready to deliver your order
-  Forklift and access equipment on all large vehicles
-  1000s of stocked items replenished each week
-  No supply chain issues
-  Unbeatable delivery service
-  Manufacturer and supplier all-in-one

DELIVERED DIRECT-TO-SITE

Briarwood will handle all transport and logistics saving you time and doesn't leave you with a headache.

All of our larger vehicles come with offloading equipment and we will work with you providing an unbeatable delivery service.

When you place an order with us, we will personally deliver your goods to a specified location on your preferred delivery date.

Briarwood have transport vehicles to cater for any sized delivery; no matter how far.





01934 641 446



briarwoodproducts.co.uk



sales@briarwoodproducts.co.uk